

PHYSICS IGCSE 2012 EXAM REVISION NOTES

By Samuel Lees and Adrian Guillot

1. **General physics**
 - 1.1 [length and time](#)
 - 1.2 [Speed, velocity and acceleration](#)
 - 1.3 [Mass and weight](#)
 - 1.4 [Density](#)
 - 1.5 [Forces](#)
 - a. [Effects of forces](#)
 - b. [Turning effect](#)
 - c. [Conditions for equilibrium](#)
 - d. [Centre of mass](#)
 - e. [Scalars and vectors](#)
 - 1.6 [Energy work power](#)
 - a. [Energy](#)
 - b. [Energy resources](#)
 - c. [Work](#)
 - d. [Power](#)
 - 1.7 [Pressure](#)
2. **Thermal physics**
 - 2.1
 - a. [States of matter](#)
 - b. [Molecular model](#)
 - c. [Evaporation](#)
 - d. [Pressure changes](#)
 - 2.2 [Thermal properties](#)
 - a. [Thermal expansion of solids, liquids and gases](#)
 - b. [Measurement of temperature](#)
 - c. [Thermal capacity](#)
 - d. [Melting and boiling](#)
 - 2.3 [Transfer of thermal energy](#)
 - a. [Conduction](#)
 - b. [Convection](#)
 - c. [Radiation](#)
 - d. [Consequences of energy transfer](#)
3. **Properties of waves, including light and sound**
 - 3.1 [General wave properties](#)
 - 3.2 [Light](#)
 - a. [Reflection of light](#)
 - b. [Refraction of light](#)
 - c. [Thin converging lens](#)
 - d. [Dispersion of light](#)
 - e. [Electromagnetic spectrum](#)
 - 3.3 [Sound](#)
4. [Electricity and magnetism](#)

- 4.1 [Simple phenomena of magnetism](#)
- 4.2 [Electrical quantities](#)
 - a. [Electric charge](#)
 - b. [Current](#)
 - c. [Electro-motive force](#)
 - d. [Potential difference](#)
 - e. [Resistance](#)
 - f. [Electrical energy](#)
- 4.3 [Electric circuits](#)
 - a. [Circuit diagrams](#)
 - b. [Series and parallel circuits](#)
 - c. [Action and use of circuit components](#)
 - d. [Digital electronics](#)
- 4.4 [Dangers of electricity](#)
- 4.5 [Electromagnetic effects](#)
 - a. [Electromagnetic induction](#)
 - b. [a.c. generator](#)
 - c. [Transformer](#)
 - d. [The magnetic effect of a current](#)
 - e. [Force on a current carrying conductor](#)
 - f. [d.c. motor](#)
- 4.6 [Cathode-ray oscilloscopes](#)
 - a. [Cathode rays](#)
 - b. [Simple treatment of cathode-ray oscilloscope](#)
- 5. [Atomic physics](#)
 - 5.1 [Radioactivity](#)
 - a. [Detection of radioactivity](#)
 - b. [Characteristics of the three kinds of emission](#)
 - c. [Radioactive decay](#)
 - d. [Half-life](#)
 - e. [Safety precautions](#)
 - 5.2 [The nuclear atom](#)
 - a. [Atomic model](#)
 - b. [Nucleus](#)
 - c. [Isotopes](#)

Units for IGCSE:

| | quantity | unit | symbol | other units |
|-----------------|------------------------|--|-----------------------|------------------|
| SI UNITS | mass | kilogram | Kg | g |
| | length | metre | m | cm |
| | time | second | s | h, min |
| | area | square metre | m² | cm ² |
| | volume | cubic metre | m³ | cm ³ |
| | force | newton | N | - |
| | weight | newton | N | - |
| | pressure | pascal | Pa | N/m ² |
| | energy | joule | J | kWh |
| | work | joule | J | - |
| | power | watt | W | - |
| | frequency | hertz | Hz | - |
| | PD, EMF | volt | V | - |
| | current | ampere | A | - |
| | resistance | ohm | Ω | - |
| | charge | coulomb | C | - |
| | capacitance | farad | F | - |
| | temperature | Kelvin degree Celsius | K °C | - |
| | specific heat capacity | joules per kilogram ° Celsius | J/(kg°C) | J/(g°C) |
| | specific latent heat | joules per kilogram | J/kg | J/g |
| | latent heat | joule | J | - |
| | speed | metres per second | m/s | cm/s or km/h |
| | acceleration | metres per second per second | m/s ² | |

1.1 Length and time

Length:

- A **rule** (ruler) is used to measure length for distances between 1mm and 1meter; the SI unit for length is the meter (m)
- To find out the volume of a **regular object**, you can use a mathematical formula, you just need to make a couple of length measurements.
- To measure the volume of an **irregular object** you have to put the object into **measuring cylinder** with water. When you add the object it displaces the water, making the water level rise. Measure this rise. This is the volume of your object.

•Micrometers:

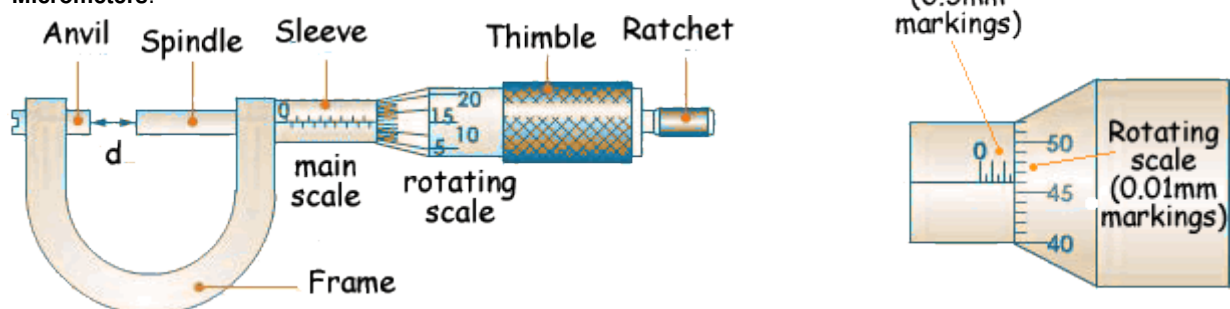

Rotate the thimble until the wire is firmly held between the anvil and the spindle.

To take a reading, first look at the main scale. This has a linear scale reading on it. The long lines are every millimetre the shorter ones denote half a millimetre in between. Then look at the rotating scale. Add the 2 numbers, on the scale on the right it would be: 2.5mm + 0.46mm = 2.96mm

Time:

- An interval of time is measured using clocks, the SI unit for time is the second(s)
- To find the amount of time it takes a pendulum to make a spin, time ~25 circles and then divide by the same number as the number of circles.

1.2 Speed, velocity and acceleration

- **Speed** is the distance an object moves in a time frame. It is measured in metres/second (m/s) or kilometres/hour (km/h).

$$\text{speed} = \text{distance moved} / \text{time taken}$$

Distance/time graphs and speed/time graphs:

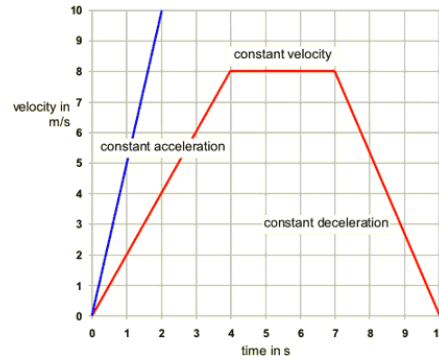
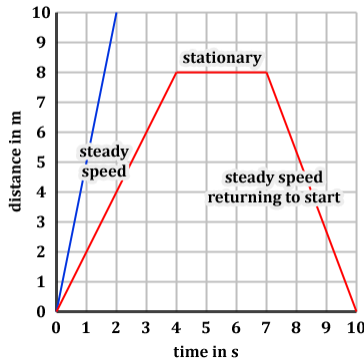

- Calculating distance travelled:
 - with constant speed: speed \times time
 - with constant acceleration: (final speed + initial speed)/2 \times period of acceleration
- Acceleration is the change in velocity per unit of time, measured in metres per second per second, or m/s² or ms⁻².

$$\text{average acceleration} = \text{change in velocity} / \text{time taken}$$

$$a = v - u / s$$

An increase in speed is a **positive acceleration**, a decrease in speed is a **negative acceleration / deceleration / retardation**.

- If acceleration is not constant, the speed/time graph will be curved.
- The downwards acceleration of an object is caused by gravity. This happens most when an object is in **free fall** (falling with nothing holding it up). Objects are slowed down by air resistance. Once air resistance is equal to the force of gravity, the object has reached **terminal velocity**. This means that it will stay at a constant velocity. (This varies for every object). The value of g (gravity) on Earth is 9.81m/s². However **10m/s²** can be used for most calculations. Gravity can be measured by using:

$$\text{Gravity} = 2 \times \text{height dropped} / (\text{time})^2$$

$$g = 2h / t^2$$

This only works when there is no air resistance, so a vacuum chamber is required.

1.3 Mass and weight

- **Mass**: the property of an object that is a measure of its inertia (a resistance to accelerate), the amount of matter it contains, and its influence in a gravitational field.
- **Weight** is the force of gravity acting on an object, measured in Newtons, and given by the formula:

$$\text{Weight} = \text{mass} \times \text{acceleration due to gravity}$$

- Weights (and hence masses) may be compared using a balance

1.4 Density

- To determine the density of a liquid place a measuring cylinder on a balance, then fill the measuring cylinder with some liquid. The change in mass is the mass of the liquid and the volume is shown on the scale, then use the formula:

$$\text{Density} = \text{mass} / \text{volume}$$

- To determine the density of an object you use the methods mentioned in [section 1.1](#) to find out volume and then weigh the object and then use the formula.

1.5 Forces

1.5 (a) Effects of forces

- A force may produce a change in size and shape of a body, give an acceleration or deceleration or a change in direction depending on the direction of the force.
- Extension/load graph:

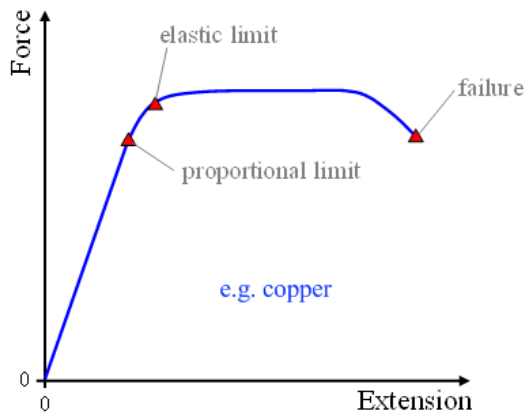

Experiment:

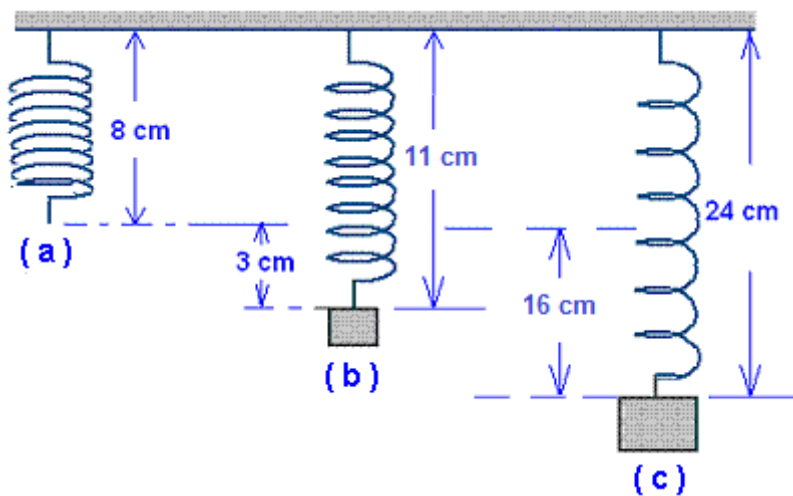

- Finding the **resultant force** of two or more forces acting along the same line:

$$\begin{array}{c} \xrightarrow{5} + \xrightarrow{5} = \xrightarrow{10} \end{array}$$

$$\begin{array}{c} \xrightarrow{5} + \xleftarrow{5} = 0 \end{array}$$

- **Hooke's Law:** springs extend in proportion to load, as long as they are under their proportional limit.

$$\text{Load (N)} = \text{spring constant (N/mm)} \times \text{extension (mm)}$$

$$F = kx$$

- **Limit of proportionality:** point at which load and extension are no longer proportional

Elastic limit: point at which the spring will not return to its original shape after being stretched

$$\text{Force} = \text{mass} \times \text{acceleration}$$

Forces are measured in Newtons. 1 Newton is the amount of force needed to give 1kg an acceleration of 1m/s^2 (if you think about it using the equation it's really obvious: if force = mass \times acceleration then 1 Newton = $1\text{kg} \times 1\text{m/s}^2$)

Circular motions

An object at steady speed in a circular orbit is always accelerating as its direction is changing, but it gets no closer to the centre

- **Centripetal force** is the force acting towards the centre of a circle. It is a force that is **needed** (not caused by) a circular motion, for example when you swing a ball on a string round in a circle, the tension of the string is the centripetal force. If the string is cut then the ball will travel in a straight line at a tangent to the circle at the point where the string was cut (Newton's first law)

- **Centrifugal force** also known as the **nonexistent force** is the force acting away from the centre of a circle. This is what makes a slingshot go outwards as you spin it. The centrifugal force is the reaction to the centripetal force (Newton's third law). It has the same magnitude but opposite direction to the centripetal force ("equal but opposite").

$$\text{centripetal force} = \text{mass} \times \text{velocity}^2 / \text{radius}$$

Newton's laws are not in the syllabus but if it helps here they are:

Newton's 1st law of motion: If no external force is acting on it, an object will, if stationary, remain stationary, and if moving, keep moving at a steady speed in the same straight line

Newton's 2nd law of motion: $F = m \times a$ -acceleration is proportional to the force, and inversely proportional to mass

Newton's 3rd law of motion: if object A exerts a force on object B, then object B will exert an equal but opposite force on object A

or, more simply:

To every action there is an equal but opposite reaction

1.5 (b) Turning effect

Moment of a force about a pivot (Nm) = force (N) x distance from pivot (m)

Moments of a force are measured in Newton meters, can be either **clockwise** or **anticlockwise**.

•Turning a bolt is far easier with a wrench because the distance from the pivot is massively increased, and so is the turning effect (this also applies to pushing a door open from the handle compared to near the hinge).

• If you have a beam on a pivot then:

-if the clockwise moments are greater, then the beam will tilt in the clockwise direction and vice versa.

-if clockwise moments = anticlockwise moments then the beam is in **equilibrium**.

The only thing which isn't really easy about moments:

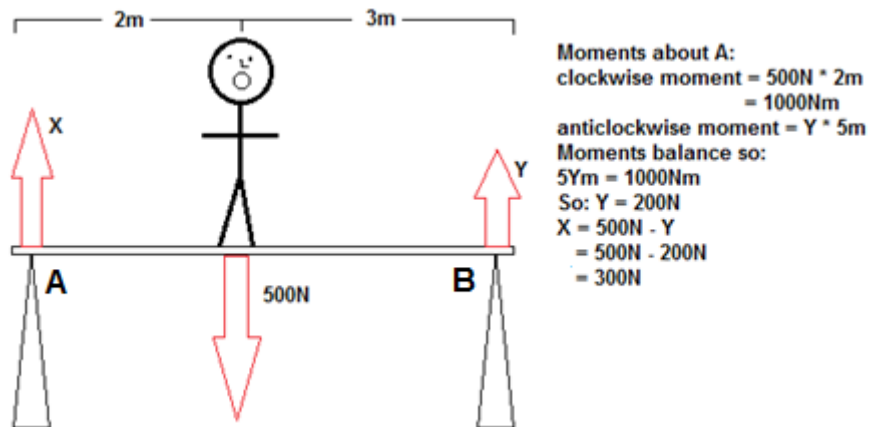

1.5 (c) Conditions for equilibrium

• If a beam is in equilibrium, there is no resultant moments.

1.5 (d) Centre of mass

Centre of mass is an imaginary point in a body (object) where the total mass of the body can be thought to be concentrated to make calculations easier

To find the centre of gravity on a flat object, use the following steps:

1. Get a flat object.
2. Get a stand and a **plumb line** (a string with a weight on it).
3. Punch 3 holes in your object.
4. Hang your object from the hole, and attach the plumb line to the same hole.

Draw a vertical line where the plumb line is.

5. Repeat step 4 for all the other holes. Where the lines meet is the centre of gravity.

(FYI the string should be able to swing freely, so should not touch the paper)

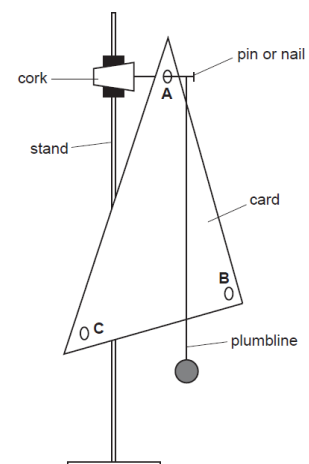

For **stability** the centre of mass must be over the centre of pressure.

1.5 (e) Scalars and vectors

• A **scalar** is a quantity that only has a magnitude (so it can only be positive) for example speed. A **vector** quantity has a direction as well as a magnitude, for example velocity, which can be negative.

• More ways to add vectors (Pythagoras's theorem and the parallelogram rule):

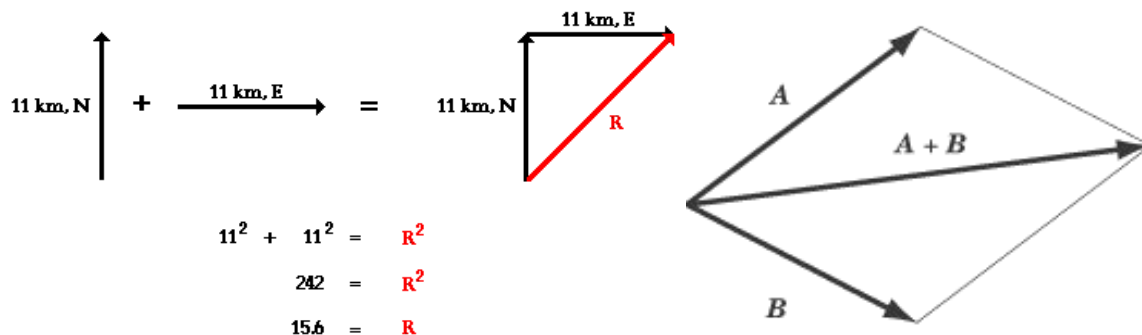

1.6 Energy, work and power

1.6 (a) Energy

• An object may have energy because of its movement (**kinetic energy**) or because of its position, for example a book on a shelf has **gravitational potential energy** - it can fall off the shelf. Energy can be **transferred** from one type to another for example if the book falls off the shelf its gpe is turned into ke. Energy is **stored** for example the book stores gpe, or a starch molecule stores **chemical energy** in its bonds. An object can transfer its energy to another object too, for example conducting heat.

| Energy type | What is it? | example | |
|------------------------------------|--|--|--------------------------|
| Kinetic energy | energy due to motion | any moving object | |
| Gravitational potential energy | energy from the potential to fall | a book on a shelf | |
| Chemical potential energy | energy stored in chemical bonds | glucose molecules have energy, but starch has more bonds so stores more energy | |
| Strain or elastic potential energy | something compressed or stretched has the potential to do work | compressed spring and stretched elastic band | |
| Nuclear potential energy | energy released when particles in atoms are rearranged or an atom splits | energy is released when atoms are made to decay in nuclear power stations | |
| Internal energy | kinetic + potential energy | - | |
| Electrical potential energy | the energy carried by electrons | energy transferred from a battery to a bulb | |
| Radiated energy | light | energy carried in light waves | light from the sun |
| | sound | energy carried in sound waves | sound from a loudspeaker |

• The **conservation of energy principle**: energy cannot be created or destroyed, when work is done, energy is changed from one form to another. The most everyday example of this is when we move, our cells turn chemical energy (in glucose bonds) into thermal and kinetic energy.

$$\text{Kinetic energy (J)} = \frac{1}{2} \times \text{Mass} \times \text{Velocity}^2$$

$$\text{ke} = \frac{1}{2} \times m \times v^2$$

$$\text{Gravitational Potential Energy (J)} = \text{Mass (kg)} \times \text{Gravity (m/s}^2\text{)} \times \text{Height (m)}$$

$$\text{gpe} = m \times g \times h$$

1.6 (b) Energy resources

• **Renewable** source of energy: is inexhaustible, for example solar, hydroelectric, wind etc.

Non-renewable source of energy: is exhaustible for example fossil fuels

• **fuels** can be burnt (or nuclear fuel can be forced to decay) in thermal power stations to transform the chemical energy stored to thermal energy which makes steam which turns turbines (kinetic energy) to produce electricity

-advantage: cheap, plentiful, low-tech

-disadvantage: harmful wastes - produces greenhouse gases and pollutant gases, radiation...

• **hydroelectric dams**: river and rain water fill up a lake behind a dam. As water rushes down through the dam, it turns turbines which turn generators

•**tidal power scheme**: a dam is built across a river where it meets the sea. The lake behind the dam fills when the tide comes in and empties when the tide goes out. The flow of water turns the generator.

-**advantage**: no greenhouse gases are produced

-**disadvantage**: expensive, can't be built everywhere

•**wave energy**: generators are driven by the up and down motion of the waves at sea.

-**advantage**: does not produce greenhouse gases

-**disadvantage**: difficult to build

•**geothermal resources**: water is pumped down to hot rocks deep underground and rises as steam.

-**advantage**: no carbon dioxide is produced

-**disadvantage**: deep drilling is difficult and expensive

•**nuclear fission**: uranium atoms are split by shooting neutrons at them.

-**advantage**: produces a lot of energy from using very little resources

-**disadvantage**: producing radioactive waste

•**solar cells**: are made of materials that can deliver an electrical current when they absorb light energy

•**solar panels**: absorb the energy and use it to heat water

-**advantage**: does not produce carbon dioxide

-**disadvantage**: variable amounts of sunshine in some countries

• **Efficiency**: how much useful work is done with the energy supplied.

$$\text{Efficiency (\%)} = \text{Useful Work Done (J)} / \text{Total Energy Input (J)}$$

$$\text{Efficiency (\%)} = \text{Useful Energy Output (J)} / \text{Total Energy Input (J)}$$

$$\text{Efficiency (\%)} = \text{Useful Power Output (W)} / \text{Total Power Input (W)}$$

•In the sun, energy is created through a process called **nuclear fusion**: hydrogen nuclei are pushed together to form helium.

1.6 (c) Work

•**Work** is done when ever a force makes something move. The unit for work is the **Joule (J)**. 1 joule of work = force of 1 Newton moves an object by 1 metre (again, if you employ the formula its common sense)

$$W = F \times d$$

$$\text{Work done (J)} = \text{Force (N)} \times \text{Distance (m)}$$

1.6 (d) Power

$$\text{Power (W)} = \text{Work done (J)} / \text{Time Taken (s)}$$

1.7 Pressure

•If a heavier person steps on your foot, it hurts more than if a light person does it. If someone with high heels steps on your foot then it hurts more than if someone with large flat shoes does it, so we know that if force increases, pressure increases and if area decreases, pressure increases and vice versa.

$$\text{Pressure (Pa)} = \text{Force (N)} / \text{area (m}^2\text{)}$$

$$P = F/A$$

•The barometer has a tube with vacuum at the top and mercury filling the rest. The pressure of the air pushes down on the reservoir, forcing the mercury up the tube. You measure the height of the mercury in the test tube, and the units used are **mm of mercury**. ~760 mm of mercury is 1 atm.

•A **manometer** measures the pressure difference. The height difference shows the **excess pressure**: the extra pressure in addition to atmospheric pressure.

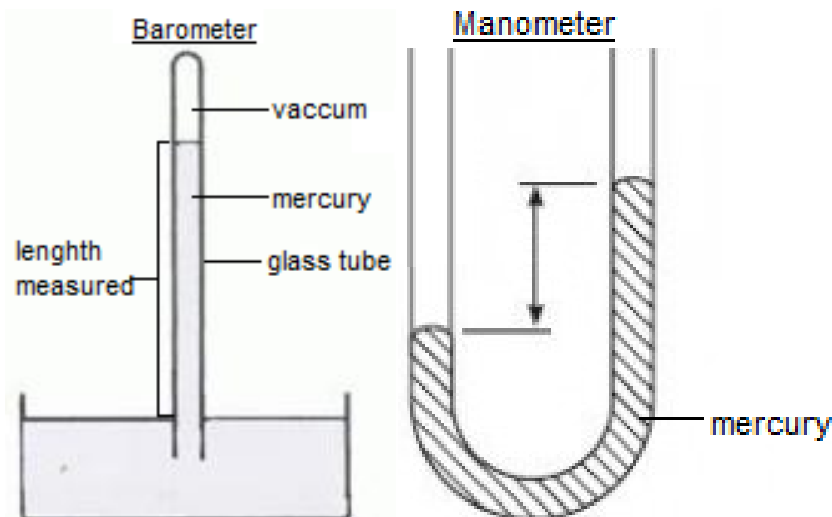

•Pressure in liquids is called **hydrostatic pressure**. It increases with depth and given by this formula:

$$p = \rho \times g \times h$$

$$\text{Pressure (Pa)} = \text{Density (kg/m}^3\text{)} \times \text{Gravity (m/s}^2\text{)} \times \text{Height (m)}$$

2. Thermal physics

2.1 Simple kinetic molecular model of matter

2.1 (a) States of matter

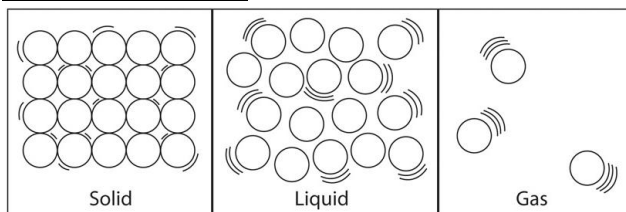

Solid: fixed shape and volume

Liquid: has fixed volume but changes shape depending on its container

Gases: no fixed shape or volume, gases fill up their containers

2.1 (b) Molecular model

Solid:

1. Strong forces of attraction between particles
2. Have a fixed pattern (lattice)
3. Atoms vibrate but can't change position.

Liquid:

1. Weaker attractive forces than solids
2. No fixed pattern
3. Particles slide past each other.

Gas:

1. Almost no intermolecular forces
2. Particles are far apart, and move quickly, gases spread out to fill up the container and exert equal pressure on all surfaces.
3. They collide with each other and bounce in all directions.

•The hotter a material is, the faster its particles move, and the more internal energy they have.

•The pressure gases exert on a container is due to the particles colliding on the container walls.

•If the volume is constant, then increasing the temperature will increase the pressure.

•If you look at smoke through a microscope, you will see the particles move in a zigzag motion. This is known as

Brownian motion. The smoke particles have very little mass but are larger enough to be seen. They collide with the air particles randomly and move in different directions, to give a random motion.

•Liquids and gases do not have a fixed shape because of their weak forces of attraction. Gases can be compressed because there is plenty of space between the particles; solids can't because such space does not exist. The particles in a solid cannot move because they are held tightly together by the attractive forces, but can vibrate.

2.1 (c) Evaporation

•**Evaporation:** constantly occurs on the surface of liquids. It is the escape of the more energetic particles. If the more energetic particles escape, the liquid contains fewer high energy particles and more lower energy particles so the average temperature decreases.

•Evaporation can be accelerated by:

-**increasing temperature:** more particles have enough energy to escape

-**increasing surface area:** more molecules are close to the surface

-**reduce the humidity level in the air:** molecules in the water vapour return to the liquid at around the same rate that particles escape the liquid, when the air is humid. If the air is less humid, fewer particles are condensing.

-**blow air across the surface:** removes molecules before they can return to the liquid

2.1 (d) Pressure changes

The relationship between pressure and volume of a fixed amount of gas at a fixed temperature can be expressed by the formula:

$$P_1 \times V_1 = P_2 \times V_2$$

This is also known as **Boyle's law**. This is proven by the kinetic theory. If the volume is halved and the same amount of gas is on the inside of the container, twice as many impacts will occur on the surface.

2.2 Thermal properties

2.2 (a) Thermal expansion of solids, liquids and gases

•Solids, liquids and gasses expand when they are heated as the atoms vibrate more and this causes them to become further apart, taking up a greater volume.

•Everyday applications and consequences:

-hot water is used to heat up a lid of a jar, to make it expand, so that it is easier to remove

-the liquid in **thermometers** expand and contract when temperature changes, the volume of the liquid taken up in the tube can be used to find out the temperature

-**bimetal thermostat:** when the temperature gets too high, the bimetal strip bends, to make contacts separate until the temperature falls enough, then the metal strip will become straight again and the contacts touch, to maintain a steady temperature

-overhead cables have to be slack so that on cold days, when they contract, they don't snap or detach.

-gaps have to be left in bridge to allow for expansion (rollers allow the bridge to expand)

• "For a fixed mass of gas at constant pressure, the volume is directly proportional to the Kelvin temperature."

•Expansion is highest in gases, then liquids and lowest in solids.

2.2 (b) Measurement of temperature

•A physical property that varies with temperature may be used for measurement of temperature for example:

-**liquid-in-glass thermometer:** the property is thermal expansion. As temperature rises or falls, the liquid (mercury or alcohol) expands or contracts. The amount of expansion can be matched to a temperature on the scale.

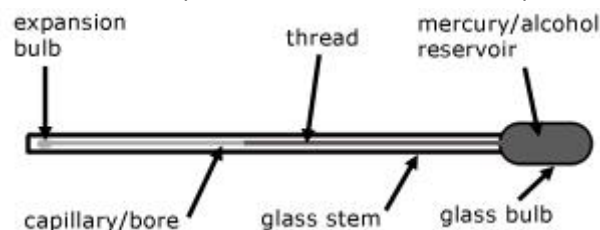

-**thermistor thermometer** (left): the probe contains a thermistor is a material that becomes a better electrical conductor when the temperature rises, so a higher current flows from a battery, causing a higher reading on the meter.

-**thermocouple thermometer** (right): the probe contains 2 different metals joined metals to form 2 junctions. The temperature difference causes a tiny voltage which makes a current flow. A greater temperature difference gives a greater current. Thermocouple thermometers are used for high temperatures which change rapidly. They have a large range (-200C° to 1100°C) and can be connected to electrical circuits or a computer.

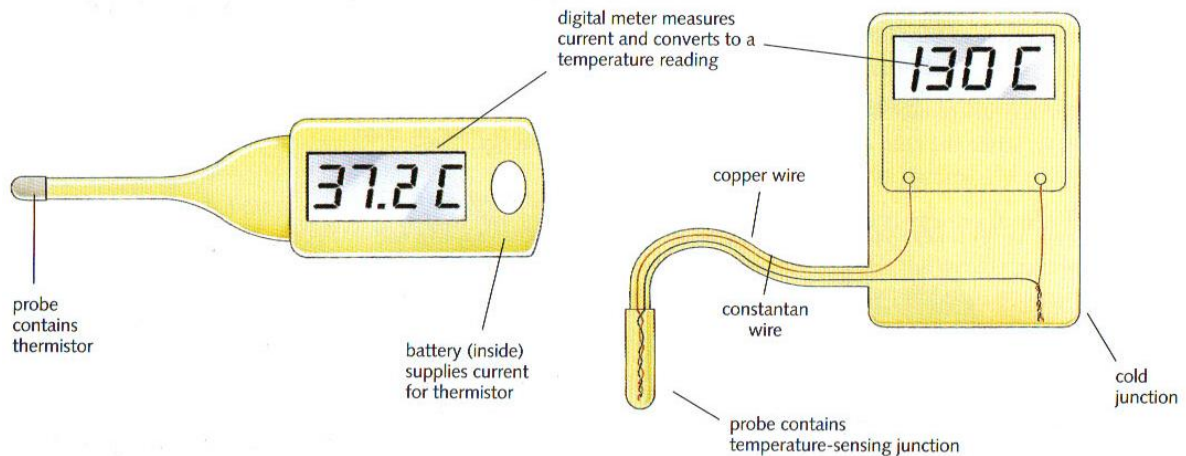

•**Fixed points** are definite temperatures at which something happens (when pure water freezes/ice melts: the **lower fixed point** or **ice point** and when pure water boils: the **upper fixed point** or **steam point**) which are used to calibrate a thermometer.

•**Calibrating a thermometer** (right):

-place thermometer in melting ice. Where the thread is now is 0 °C.

-place thermometer in boiling water. Where the thread is now is 100 °C.

•**Sensitivity:**

To increase the sensitivity of thermometers you have to put the liquid in a narrower tube. This makes more distance for same amount of expansion of liquid. Mercury expands less than alcohol. Sensitivity can be increased by using a material that expands more during a temperature change.

•**Range:**

The maximum and minimum temperature of thermometers

Mercury = -39 °C to 500 °C

Alcohol = -115 °C to 68 °C

•**Responsiveness:**

How long it takes for the thermometer to react to a change in temperature (increased by making the glass bulb thinner or making the bulb smaller)

•**Linearity:**

If the sizes of the individual degrees are closer to each other then it is more linear.

2.2 (c) Thermal capacity

•When something has a rise in temperature, its **internal energy** increases.

•**Thermal capacity:** capacity for absorbing thermal energy, given by this formula:

$$\text{Thermal capacity} = \text{specific heat capacity (J/Kg)} \times \text{mass}$$

•**Specific heat capacity:** is the amount of energy needed to raise the temperature of 1 kilogram of a substance by 1°C, the unit for specific heat capacity is **J/(Kg°C)**

$$\text{Specific heat capacity} = \text{energy transferred} / (\text{mass} \times \text{temperature change})$$

$$c = E / (m \times \Delta T)$$

$$\text{Energy transferred} = \text{mass} \times \text{specific heat capacity} \times \text{temperature change}$$

$$E = mc \Delta T$$

•An **experiment** can be carried out to find the specific heat capacity of a substance. You should know the power of the electric heater, the amount of time it is left on, the mass of the material being tested and the temperature change. For a liquid, it can be simply poured in, but for a solid like Aluminium, holes have to be drilled in for the heater and thermometer.

Power of heater × time left on = energy supplied by heater

Energy supplied by heater / (mass × temperature change) = specific heat capacity

The experiment makes no allowance for any thermal energy lost from the beaker, so the value

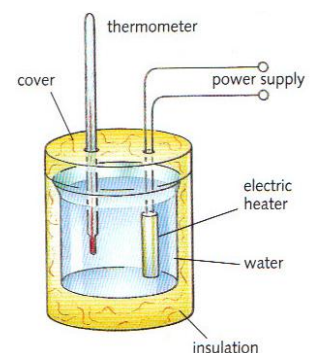
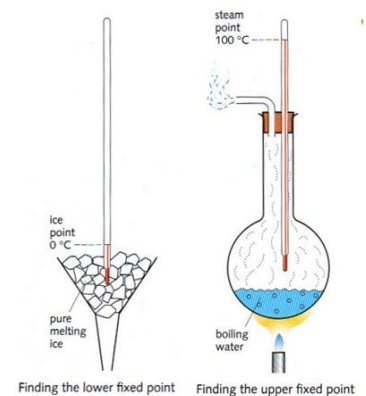

of c is approximate.

2.2 (d) Melting and boiling

•When melting or boiling a substance, energy is put in, but there is no change in temperature. The energy absorbed is called the **latent heat of fusion/vaporization**. A change of state happens when the particles have enough energy to overcome the forces between them. In melting, the solid vibrates so much that the particles can break away from their positions.

The latent heat of fusion is the amount of energy needed to melt 1Kg of a substance.

The latent heat of vaporisation is the amount of energy needed to boil 1Kg of a substance

When a substance freezes it is losing the same amount of energy as the latent heat of fusion

•**Melting point** is the temperature at which a substance (in solid state) melts (it is equal to the freezing point)

•**Boiling point** is the temperature at which a substance (in liquid state) boils (“you don’t say”)

•**Condensation** and **solidification**: is when a gas turns back into a liquid. When a gas is cooled, the particles lose energy. They move more and more slowly. When they bump into each other, they do not have enough energy to bounce away again. They stay close together, and a liquid forms. When a liquid cools, the particles slow down even more. Eventually they stop moving except for vibrations and a solid forms.

•**Evaporation** and **boiling**: evaporation constantly occurs on the surface of liquids. The high energy particles escape from the liquid, even at low temperatures. Boiling occurs at the boiling point (I bet you did not know that) and then the liquid evaporates everywhere in the liquid (not just on the surface) and is much faster.

•Measure the specific latent heat of vaporisation/fusion of:

1) Ice – the apparatus is set up like in the diagram below on the left, you need to know the power of the heater, how long it is left on for, how much water is produced in kilograms then you do the following calculations:

Power \times time = energy transferred

Energy transferred / mass = latent heat of fusion

So, (power of heater \times time left on) / mass of water in beaker in kilograms = latent heat of fusion

2) Water – the apparatus is set up like in the diagram on the right. The electric heater is left on for a certain amount of time (you don’t have to boil all the water, just some of it). You need to know: power of the heater, and how long it is left on for.

Power of heater \times time left on / change in mass = latent heat of vaporization.

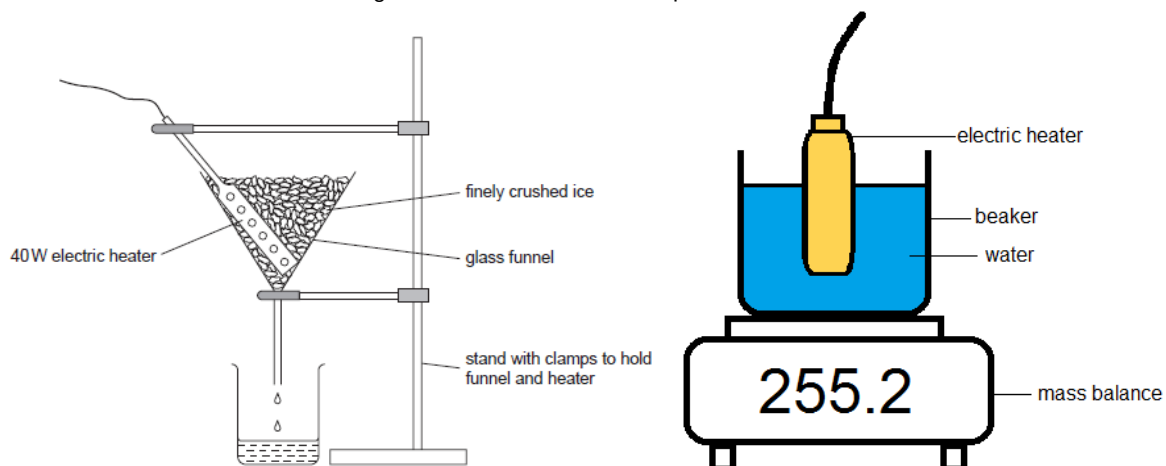

2.3 Transfer of thermal energy

2.3 (a) Conduction

These experiments show which metal is the best conductor (copper and A), and which is the worst (steel and D)

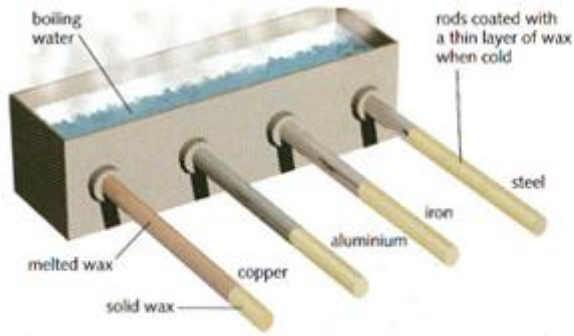

▲ Comparing four good thermal conductors. Ten minutes or so after the boiling water has been tipped into the tank, the length of melted wax shows which material is the best conductor.

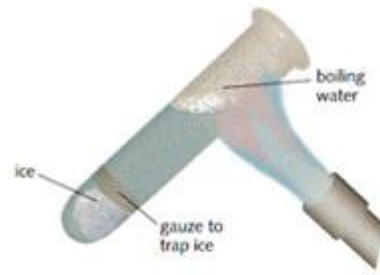

▲ This experiment shows that water is a poor thermal conductor. The water at the top of the tube can be boiled without the ice melting.

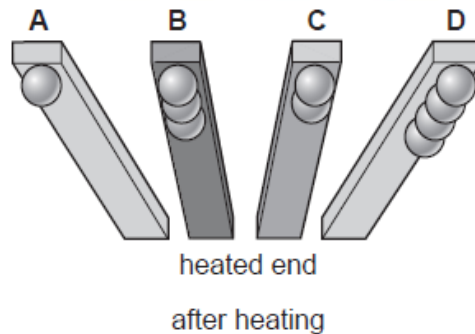
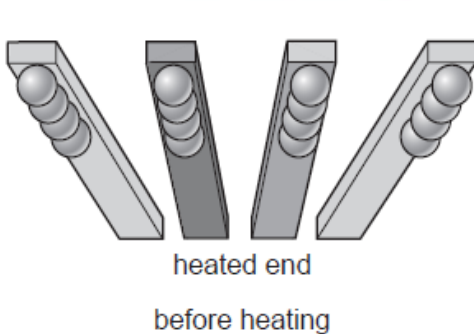

Conduction: in non-metals - when heat is supplied to something, its atoms vibrate faster and pass on their vibrations to the adjacent atoms. In metals – conduction happens in the previous way and in a quicker way – some electrons are free to move, they travel randomly in the metal and collide with atoms and pass on the vibrations.

2.3 (b) Convection

Convection: as a fluid (liquid or gas) warms up, the particles which are warmer become less dense and rise. They then cool and fall back to the heat source, creating a cycle called a **convection current**. As particles circulate they transfer energy to other particles. If a cooling object is above a fluid it will create a convection current (like the freezing compartment at the top of a fridge)

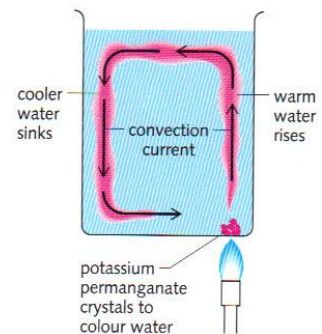

2.3 (c) Radiation

Thermal radiation is mainly infra-red waves, but very hot objects also give out light waves. Infra-red radiation is part of the electromagnetic spectrum.

| | | | |
|-----------|------------|-------|--------|
| | Matt Black | White | Silver |
| emitter | best | | worst |
| reflector | worst | | best |
| absorber | best | | worst |

An emitter sends out thermal radiation. A reflector reflects thermal radiation, therefore is a bad absorber. An emitter will cool down quickly, an absorber will heat up more quickly and a reflector will not heat up quickly.

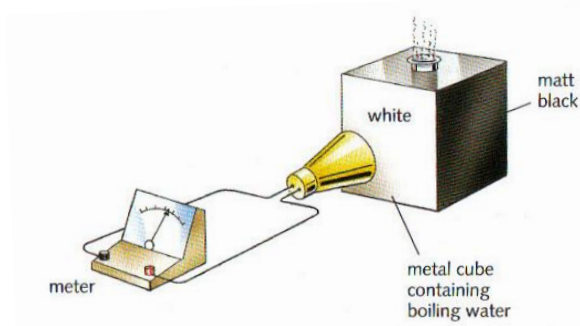

Comparing emitters The metal cube is filled with boiling water which heats the surfaces to the same temperature. The thermal radiation detector is placed in turn at the same distance from each surface and the meter readings compared.

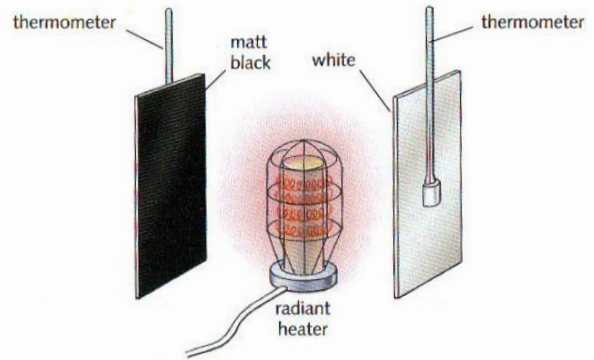

Comparing absorbers The metal plates are placed at the same distance from a radiant heater. To find out which surface absorbs thermal radiation most rapidly, the rises in temperature are compared.

2.3 (d) Consequences of energy transfer

Applications

- solar panel: the sun's thermal radiation is absorbed by a matt black surface and warms up the pipes containing water
- refrigerator: the freezer compartment is located at the top of the refrigerator. It cools down the air which then sinks. Any warm air rises to the top and then is cooled. This creates a convection current which maintains a cold temperature.
- metals are used in cooking pans because they conduct the heat well

Consequences

- a metal spoon in a hot drink will warm up because it conducts the heat
- Convection currents create sea breezes. During the day the land is warmer and acts as heat source. During the night the sea acts as the heat source.

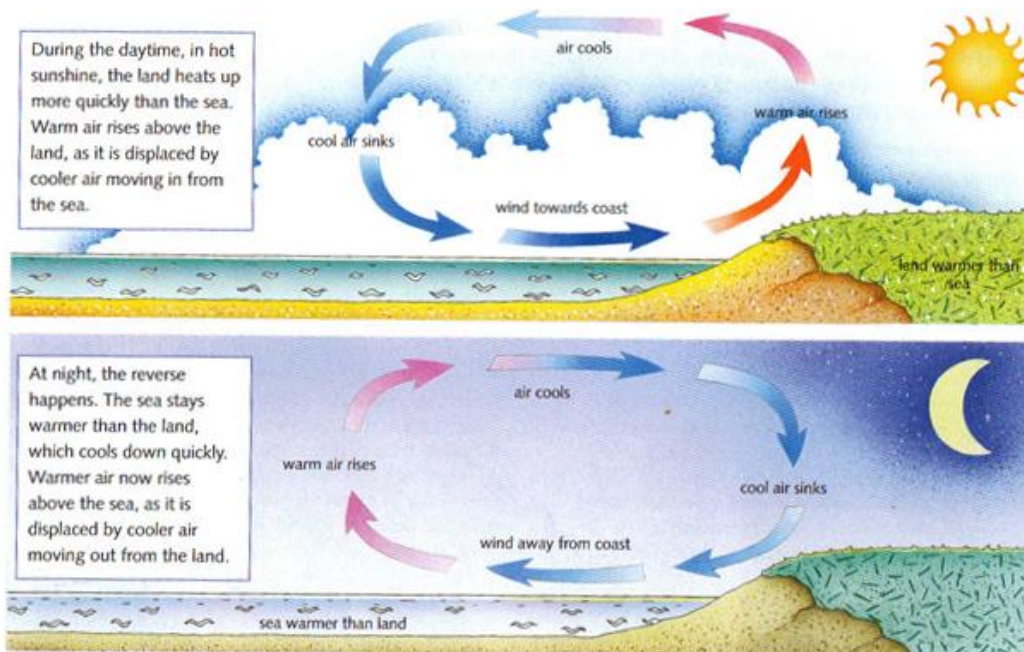

- a black saucepan cools better than a white one, white houses stay cooler than dark ones.

3. Properties of waves, including light and sound

3.1 General wave properties

- Wavefront:** the peak of a transverse wave or the compression of a longitudinal wave
- Speed:** how fast the wave travels measured in **m/s**
- Frequency:** the number of waves passing any point per second measured in **hertz (Hz)**, given by this formula:

$$\text{Frequency} = 1 / \text{period}$$

- **Wavelength:** the distance between a point on one wave (e.g. the trough) to the equivalent point on the next wave in **meters** e.g. from crest to crest or compression to compression
- **Amplitude:** the maximum distance a wave moves from its rest position when a wave passes
- **Period:** the time taken for one oscillation in **seconds**

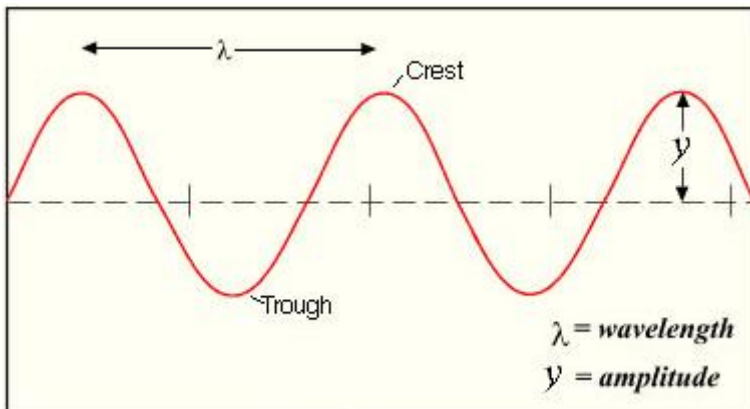

• **Transverse waves** (e.g. light waves) have oscillations at right-angles to the direction of travel, where as in **longitudinal waves** the oscillations are in the direction of travel. Transverse waves have **crests** (peaks) and **troughs**; where as longitudinal waves (e.g. sound waves) have **compressions** and **rarefactions**.

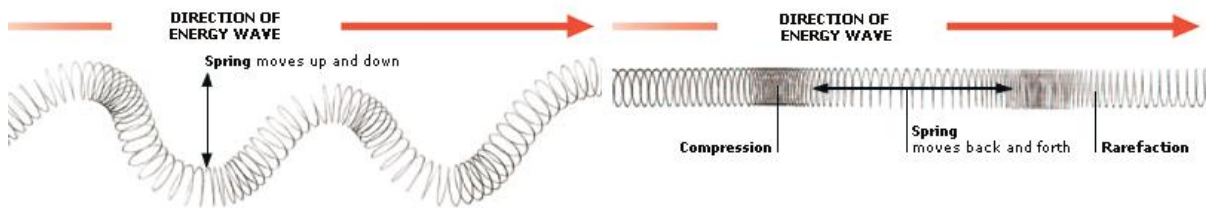

Reflection, refraction and diffraction of water waves

Refraction:

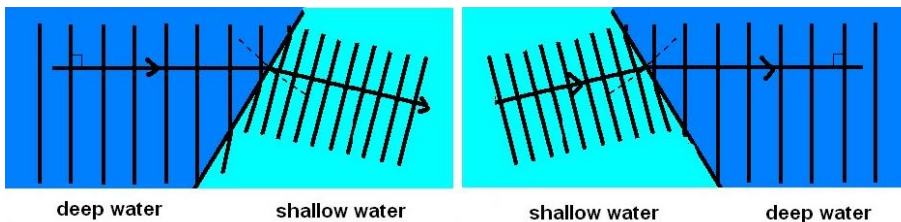

Reflection:

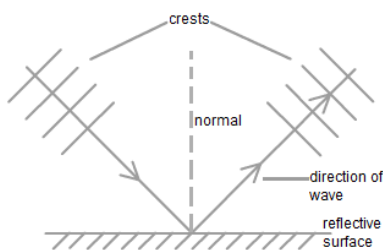

Diffraction:

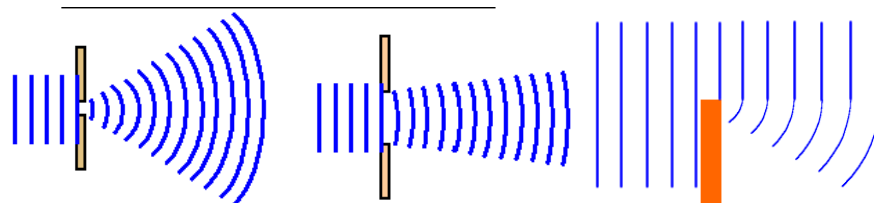

Reflection: waves bounce away from the surface at the same angle they strike it, (angle of incidence = angle of reflection).

Refraction: when the water waves pass through shallower water they slow down the waves. When waves slow down they change direction.

Things to note about refraction:

- waves slow down when they pass from a less to a more dense material and vice versa
- when a wave is slowed down, it is refracted towards the normal ($i > r$)
- when a wave is sped up, it is refracted away from the normal ($i < r$)
- deep water is denser than shallow water

Diffraction: waves bend round the sides of an obstacle, or spread out as they pass through a gap. Wider gaps produce less diffraction.

•The wave equation is:

$$\text{Speed (m/s)} = \text{Frequency (Hz)} \times \text{Wavelength (m)}$$

$$v = f \times \lambda$$

3.2 Light

3.2 (a) Reflection of light

•Plane (flat) mirrors produce a reflection. Rays from an object reflect off the mirror into our eyes, but we see them behind the mirror. The image has these properties:

- the image is the same size as the object
- the image is the same distance from the mirror as the object
- a line joining equivalent points of the image and object meet the mirror at a right angle
- the image is **virtual**: no rays actually pass through the image and the image cannot be formed on a screen

• Laws of reflection:

$$\text{Angle of incidence} = \text{angle of reflection}$$

The incident ray, reflected ray and normal are always on the same plane (side of mirror)

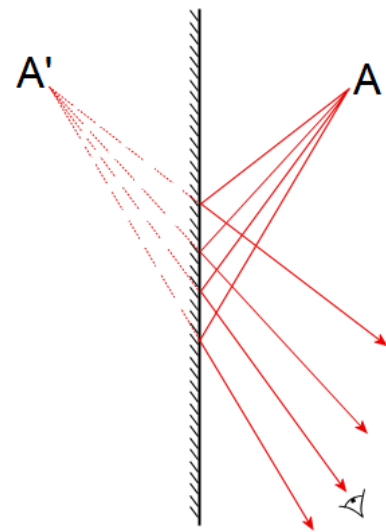

3.2 (b) Refraction of light

•Experimental demonstration: 1. the **optical pin method**:

1. Place a rectangular glass slab on a white sheet of paper fixed on a drawing board.
2. Trace the boundary ABCD of the glass slab.
3. Remove the glass slab. Draw an incident ray IO on AB.
4. Draw the normal at point of incidence (NN^1 through O)
5. Fix two pins P and Q on the incident ray IO.
6. Place the glass slab within its boundary ABCD.
7. Looking from the other side of the glass slab fix two pins R and S such that your eye and the feet of all the pins are in one straight line.
8. Remove the glass slab and the pins. Mark the pin points P_1, P_2, P_3 and P_4 .
9. Join OO^1 . It is the refracted ray.
10. Measure $\angle i, \angle r$ and $\angle e$. $\angle i, \angle r$ and $\angle e$ are the angle of incidence, angle of refraction and angle of emergence respectively.
11. $\angle i > \angle r$ and $\angle i = \angle e$
12. Extend O^1E backwards. The emergent ray is parallel to the incident ray.

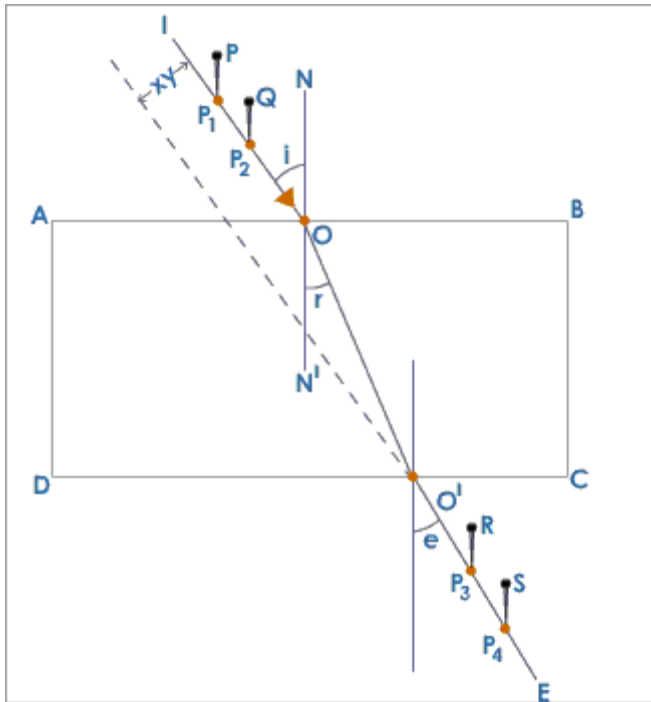

Ray box method:

Using the ray box pass a ray through a glass slab on a white sheet of paper. Mark two points on the incident ray with your pen/pencil on the paper, two of the refracted ray, 2 of the emergent ray and the outline of the glass slab. Then by connecting the dots you can produce a diagram like the one below, a protractor is used to find the angles.

•When a ray passes through a parallel sided transparent material its passage will look like this:

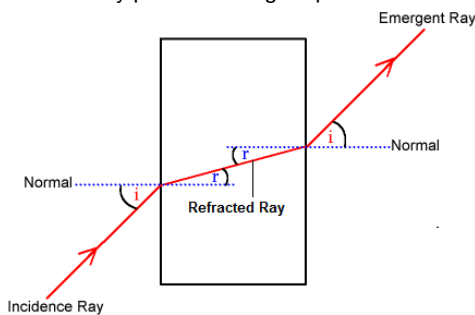

Note: the emergent ray is parallel to the incident ray.

•**Critical angle:** the angle at which the refracted ray is parallel to the surface of the material. If the angle of incidence is greater than the critical angle there is no refracted ray, there is **total internal reflection**. If the angle of incidence is less than the critical angle the incidence ray will split into a refracted ray and a weaker reflected ray.

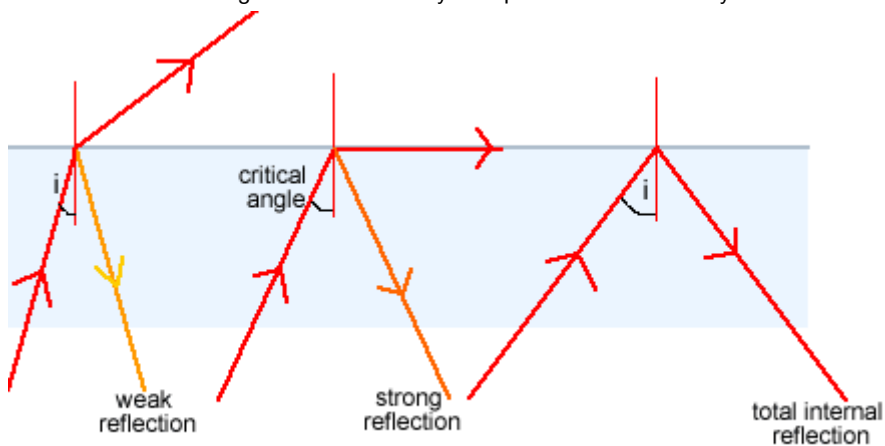

$i < \text{critical angle}$ $i = \text{critical angle}$ $i > \text{critical angle}$

Refractive index = speed of light in vacuum / speed of light in medium

$$\text{Refractive index} = \sin i / \sin r$$

When the incidence angle is equal to the critical angle, the angle of refraction is 90° (parallel to the surface). Since $\sin 90^\circ$ equals 1, then a ray coming the other way (the arrow is inverted) would have an angle of incidence of 90° and an angle of refraction of c . If we apply Snell's law:

$$n = \sin 90^\circ / \sin c$$

$$\text{Sin (critical angle)} = 1 / n$$

$$\text{Critical angle} = \sin^{-1}(1/n)$$

•**Optical fibres:** light put in at one end is totally internally reflected until it comes out the other end. This is used in communications where signals are coded and sent along the fibre as pulses of laser light, and in medicine: an endoscope, an instrument used by surgeons to look inside the body. It contains a long bundle of optic fibres.

3.2 (c) Thin converging lens

•**Principal focus:** the point where rays parallel to the principal axis converge with a converging lens.

•**Focal length:** distance from the principle focus and the optical centre.

•**Principal axis:** the line the goes through the optical centre, and the 2 foci.

•**Optical centre:** the centre of the lens

This is a **real image** (when the object is further away from the optical centre than F' is):

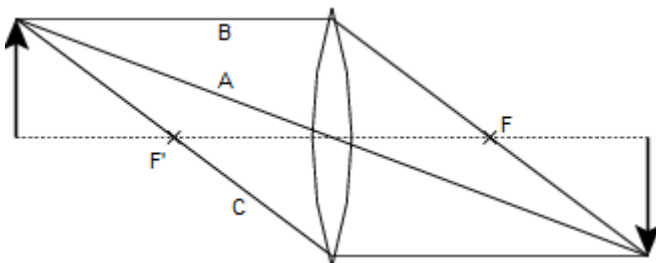

A) A ray through the centre of the lens passes straight through the lens.

B) A ray parallel to the principal axis passes through the focus on the other side of the lens

C) A ray through F' will leave the lens parallel to the principal axis.

•This is a **virtual image** (when the object is closer to the optical centre than F' is):

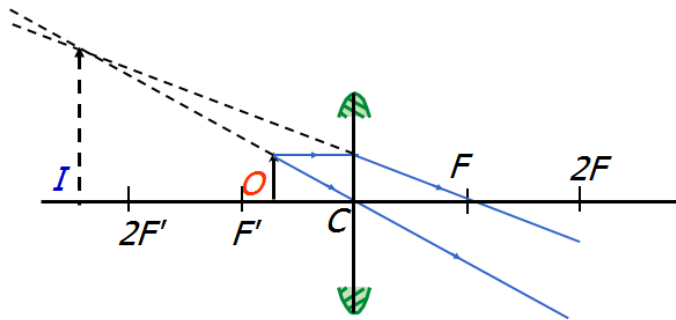

•**Magnifying glass:** when a convex lens is used like this - an object is closer to a convex (converging) lens than the principal focus (like the diagram above), the rays never converge. Instead, they appear to come from a position behind the lens. The image is upright and magnified, it is a virtual image.

3.2 (d) Dispersion of light

•Refraction by a prism: When light is refracted by a prism, the incidence ray is not parallel to the emergent ray, since the prism's sides are not parallel. If a beam of white light is passed through a prism it is **dispersed** into a **spectrum**. White light is a mixture of colours, and the prism refracts each colour by a different amount – red is deviated the least and violet the most.

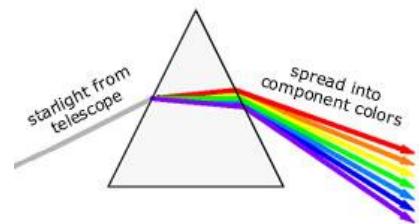

3.2 (e) Electromagnetic spectrum

•All electromagnetic waves:

-travel at the speed of light: 3×10^8 m/s

-do not need a medium to travel through i.e. can travel through a vacuum

-can transfer energy

- are produced by particles oscillating or losing energy in some way
- are transverse waves

•Uses:

Radio waves – radio and television communications

Microwaves – satellite television and telephones

Infrared – electrical appliances (radiant heaters and grills), remote controllers for televisions and intruder alarms

X-rays – medicine (x-ray photography and killing cancer cells) and security

•Safety issues:

X-rays – is a mutagen, it cause cancer (mutations)

Microwaves – cause internal heating of body tissues

•**Monochromatic**: light of a single wavelength and colour (used in lasers)

3.3 Sound

•Production: sound waves come from a vibrating source for example a loudspeaker. As the loudspeaker cone vibrates, it moves forwards and backwards, which squashes and stretches the air in front. As a result, a series of compressions (squashes) and rarefactions (stretches) travel out through the air, these are sound waves.

•Sound waves are **longitudinal**: they have compressions and rarefactions and oscillate backwards and forwards.

•Humans can hear frequencies between 20 and 20 000Hz.

•Sound waves need a **medium** (a material) to travel through.

•**Experiment**: When sound reflects off of a wall, it will come back to you. This is what you hear as an **echo**.

If you know the distance between you and the wall, and measure how long it takes for the echo to sound, you can figure out the speed of sound in air.

Remember to take into account that the sound has gone there and back

•Higher frequency → a higher pitch

Larger amplitude → louder sound

• **Compression**: high pressure section of the wave

Rarefaction: low pressure section of the wave

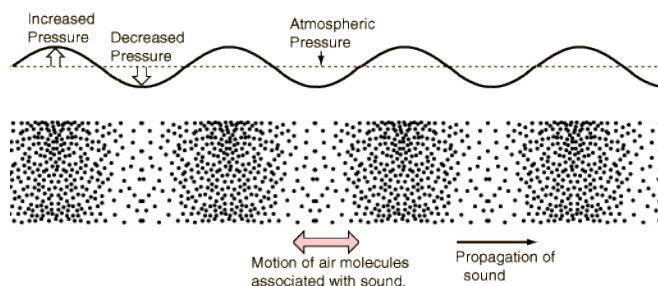

•Speed of sound is highest in solids (concrete: 5000m/s) then in liquids (pure water: 1400m/s) and slowest in gases (air: 330m/s).

4. Electricity and magnetism

4.1 Simple phenomena of magnetism

•Magnets have these **properties**:

-has a **magnetic field** around it

-has 2 opposite **poles** (**North** or north-seeking pole and **South** or south-seeking pole) which exert forces on other magnets. *Like poles repel and unlike poles attract.*

-will attract magnetic materials by **inducing** (**permanent** or **temporary**) magnetism in them.

-will exert little or no force on a non-magnetic material

•**Induced magnetism**: magnets attract materials by inducing magnetism in them, in other words the material becomes a magnet as well. The side of the material facing the magnet will become the opposite pole as the magnet.

•**Ferrous** material: magnetic – anything which contains iron, nickel, or cobalt can be magnetised

•**Non-ferrous** material: non-magnetic e.g. copper, grass, ketchup, butter, wood, ass-gravy (poop) etc.

•**Magnetisation** methods:

-inducing magnetism produces a weak magnet. It can be magnetised strongly by **stroking** with one end of a magnet, in one direction.

-the most effective method is to place the metal in a long coil of wire (**solenoid**) and pass a large DC (**direct current**) through the coil.

•**Demagnetisation** methods:

-SMASH IT WITH A HAMMER, dropping etc.

-heating to a high temperature

-solenoid method but with alternating current

•Iron vs. steel: iron is a **soft** ferromagnetic material meaning it will magnetise and demagnetise easily. Steel is a **hard** ferromagnetic material meaning it is hard to magnetise and demagnetise. Soft ferromagnetic materials are used to create temporary magnets, for example the magnets which lift cars in a rubbish dump, or the magnet in a circuit breaker. Hard ferromagnetic materials are used to create permanent magnets like fridge magnets, horse-shoe magnets. The magnetic field lines go from north to south. The north pole of a magnet can be found by placing a compass near the magnet. The needle will point the direction of the magnetic field line.

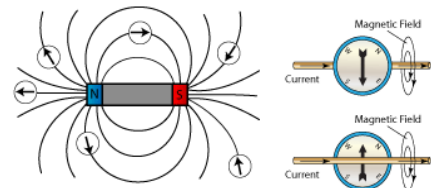

The pointer of the compass is pointing towards the direction of the field

4.2 Electrical quantities

4.2 (a) Electric charge

•Detecting charge:

You can detect an electrostatic charge using a **leaf electroscope**.

If a charged object is placed near the cap, charges are induced. The metal cap gets one type of charge (positive or negative) and the metal stem and gold leaf get the other type of charge so they repel each other.

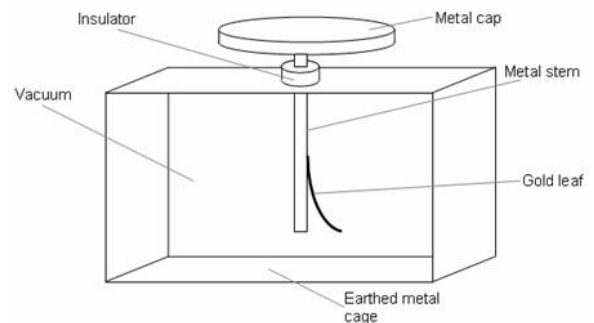

•There are 2 types of charges: **positive** and **negative**.

•Unlike charges attract and like charges repel.

•**Electric field**: a region in which an electric charge experiences a force

•**Conductors**: materials that let electrons pass through them. Metals are the best electrical conductors as they have free electrons. This also makes them good thermal conductors

•**Insulators**: materials that hardly conduct at all. Their electrons are tightly held to atoms and hardly move, but they can be transferred by rubbing

•The SI unit of charge is the **Coulomb (C)**.

Electric field lines :

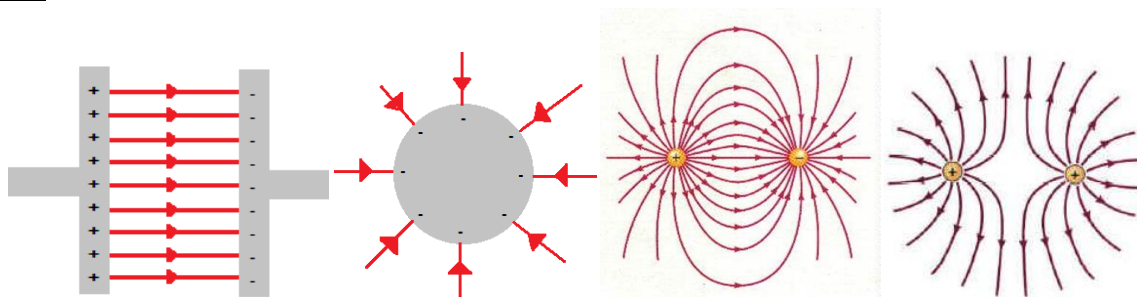

•**Induced Charge**: a charge that “appears” on an uncharged object because of a charged object nearby, for example if a positively charged rod is brought near a small piece of aluminium foil. Electrons in the foil are pulled towards the rod, which leaves the bottom of the foil with a net positive charge. The attraction is stronger than the repulsion because the attracting charges are closer than the repelling ones.

4.2 (b) Current

•**Current**: a flow of charge, the SI unit is the **Ampere (A)**.

•An **ammeter** measures the current in a circuit. It is connected in series, the current is a rate of flow of charge.

$$\text{Charge (C)} = \text{current (A)} \times \text{time (s)}$$

$$C = I \times t$$

•The **conventional current direction** is the direction the positive particles would travel in. This is the opposite of what actually happens, as it is the negative particles (electrons) that move. Conventional current is indicated with arrows on the lines (wires). Conventional current goes from the positive side (long line in cell drawing) to the negative side (short

line in cell drawing). Actual current goes from the negative side (short line in cell drawing) to the positive side (long line in cell drawing).

4.2 (c) Electro-motive force

•The maximum voltage a cell can produce is called the **electromotive force** (EMF), measured in **volts**. When a current is being supplied, the voltage is lower because of the energy wastage inside the cell. A cell produces its maximum PD when not in a circuit and not supplying current.

4.2 (d) Potential Difference

•**Potential difference**, or PD for short, is also known as **voltage**. Voltage is the amount of energy the cell gives the electrons it pushes out. Voltage is measured in **volts** (V) and is measured by a **voltmeter** (connected in parallel). If a cell has 1 Volt, it delivers 1 Joule of energy to each coulomb of charge (J/C).

$$\text{Voltage} = \text{Energy} / \text{Charge}$$

$$\text{Volts} = \text{Joules} / \text{Coulomb}$$

$$V = E / C$$

4.2 (e) Resistance

$$\text{Resistance } (\Omega) = \text{potential difference (V)} / \text{current (A)}$$

$$R = V / I$$

•Factors affecting resistance:

-Length

Double the length = double the resistance (proportional)

-Cross-sectional area

Half the cross-sectional area = double the resistance (inversely proportional)

-Material

Better conductor = less resistance

-Temperature

For metal conductors higher temperature = more resistance

For semi-metal conductors higher temperature = less resistance

The $V = IR$ law can be investigated with the following apparatus:

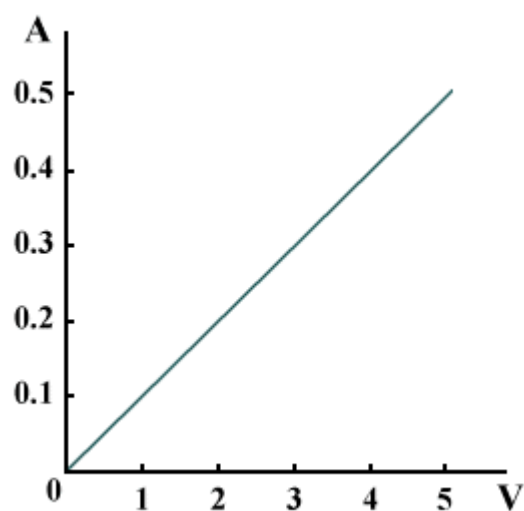
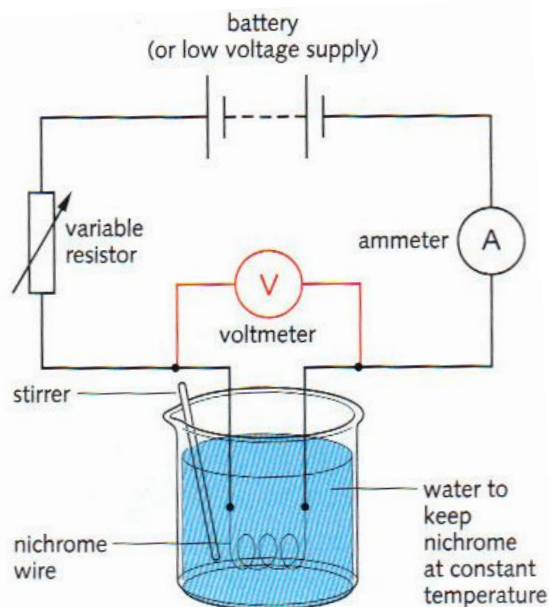

4.2 (f) Electrical energy

$$\text{Electrical power} = \text{Voltage (V)} \times \text{Current (A)}$$

$$P = V \times I$$

$$\text{Electrical energy (J)} = \text{power (W)} \times \text{time (s)}$$











$$E = P \times t$$

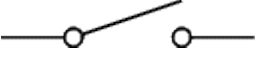
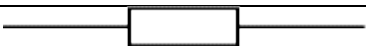

Electrical energy (J) = Voltage (V) × Current (A) × time (s)

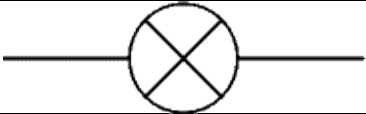
$$E = V \times I \times t$$

4.3 Electrical circuits

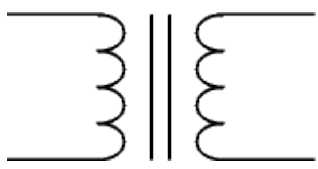
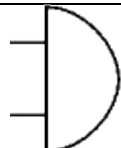
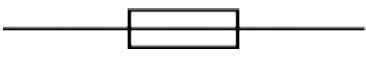
4.3 (a) Circuit diagrams

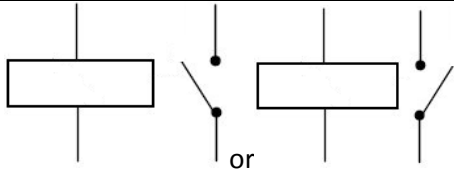
| Component | Symbol | Function |
|-------------------|--|---|
| Source | <p>Cell </p> <p>Battery </p> <p>Direct Current </p> <p>Alternating Current (Mains Supply) </p> | <p>Cell: Supplies electrical energy. The larger terminal (on the left) is positive (+).</p> <p>Battery: Supplies electrical energy. A battery is more than one cell. The larger terminal (on the left) is positive (+).</p> <p>DC: flows in one direction</p> <p>AC: flows in both directions</p> |
| Switch |  | Allows current only to flow when the switch is closed |
| Fixed resistor |  | Restrict the flow of current. |
| Variable resistor |  | Used to control current (by varying the resistance) |
| Lamp |  | Transducer which converts electrical energy to light |
| Ammeter |  | Measure current |
| Voltmeter |  | Measure voltage |
| Magnetising coil |  | < I don't know if that's the correct symbol |
| Transformer |  | Two coils of wire linked by an iron core. Transformers are used to step up (increase) and step down (decrease) AC voltages. Energy is transferred between the coils by the magnetic field in the core. There is no electrical connection between the coils. |
| Bell |  | Transducer which converts electrical energy to sound |
| Fuse |  | A safety device which will 'blow' (melt) if the current flowing through it exceeds a specified value, breaking the circuit |
| Relay | | An electrically operated switch, for example a 9V battery circuit connected to the coil can switch a 230V AC mains circuit (the one on the left is the 'normally closed') |

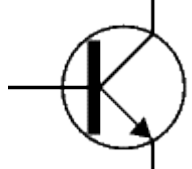
| | | |
|------------|---|---|
| |  | since the electromagnet is used to pull away the contacts and vice versa) |
| Diode |  | A device which only allows current to flow in one direction. |
| Transistor |  | A transistor amplifies current. It can be used with other components to make an amplifier or switching circuit. |

4.3 (b) Series and parallel circuits

- The current at any point in a series circuit is the same
- The current splits at each branch in a parallel circuit so the total current is always greater than the current in one branch

•Combining Resistors:

In series:

$$R_{\text{total}} = R_1 + R_2$$

In parallel:

$$R_{\text{total}} = 1/(1/R_1 + 1/R_2)$$

- The combined resistance of 2 resistors in parallel is less than that of either resistor by itself
- The advantages of putting lamps in parallel are:
 - if one lamp breaks, the other still works
 - each lamp gets maximum PD
- in series: PD across the supply = PD across all the components combined
- in parallel: Current across the source = sum of currents in the separate branches

4.3 (c) Action and use of circuit components

- A **potential divider** divides the voltage into smaller parts. To find the voltage (at V_{out}) we use the following formula:

$$V_{\text{out}} = V_{\text{in}} \times (R_2 / R_{\text{total}})$$

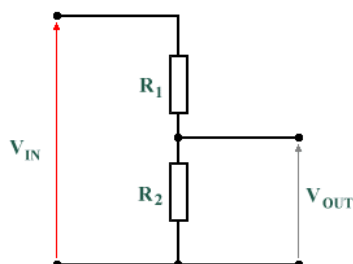

- A variable potential divider (**potentiometer**) is the same as the one above but using a variable resistor; it acts like a potential divider, but you can change the output voltage.
- Thermistor**: input sensor and a transducer. It is a temperature-dependent resistor. At higher temperature there is less resistance.
- Light dependent resistor (LDR)**: input sensor and a transducer. When light intensity increases, resistance decreases.
- Capacitor**: store small amounts of electric charge. If a capacitor has a higher **capacitance** (in μF microfarads) means they can store more charge. They are used in time-delay circuits.
- Relay**: a switch operated by an electromagnet

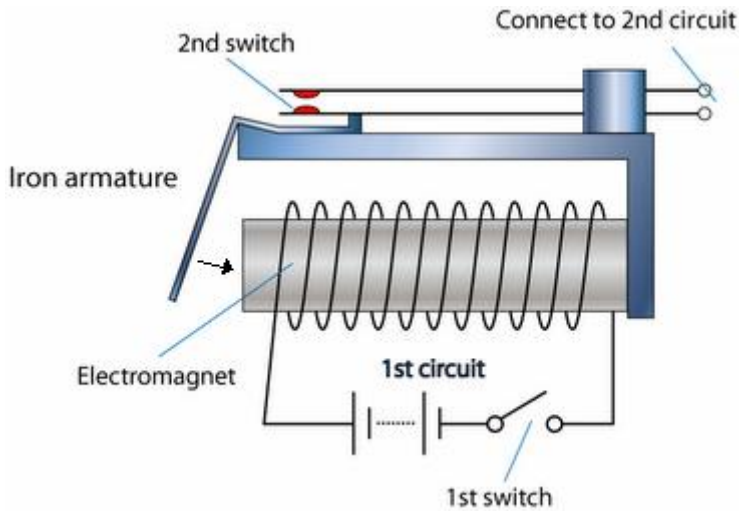

Normally closed relay (symbol):

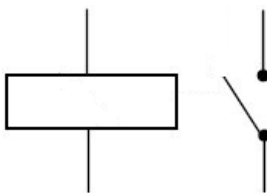

Normally open relay (symbol):

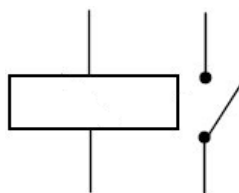

•**Diode**: a device that has an extremely high resistance in one direction and a low resistance in the other, therefore it effectively only allows current to flow in 1 direction (the arrow on it is pointing in the conventional current direction). **Forward bias** is when the diode is pointing in the direction of the conventional current and **reverse bias** is the opposite

It can be used in a **rectifier**. A rectifier turns AC current into DC current.

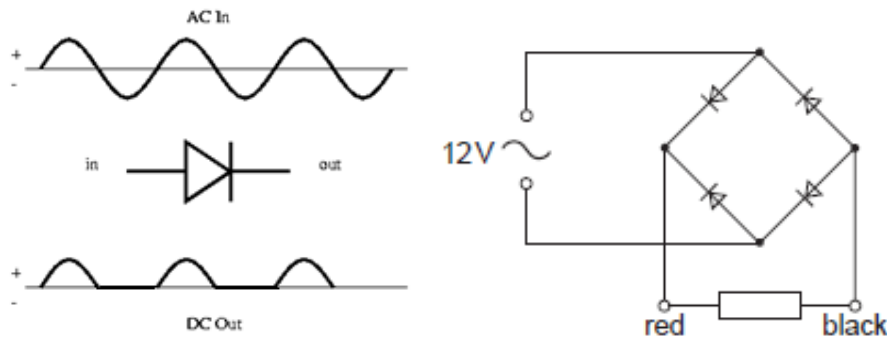

Diodes work when the PD exceeds 0.6V so the PD vs. current graph would look like this:

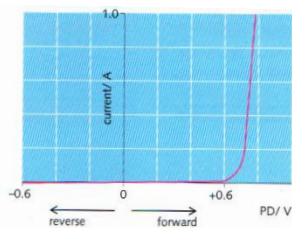

Semiconductor diode The current is not proportional to the PD. And if the PD is reversed, the current is almost zero. In effect, the diode 'blocks' current in the reverse direction.

•**Transistor**: used for amplifying signals and for switching. It has three terminals: the **emitter**, **base** and **collector**. Using a transistor, a small current in one circuit can controls a large current in the other. The conventional current direction has to be the same as the arrow for it to work. If no current travels from the base to the emitter, the transistor has a blocking effect (on the left):

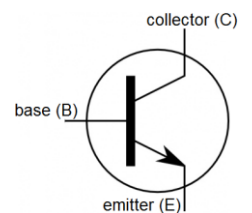

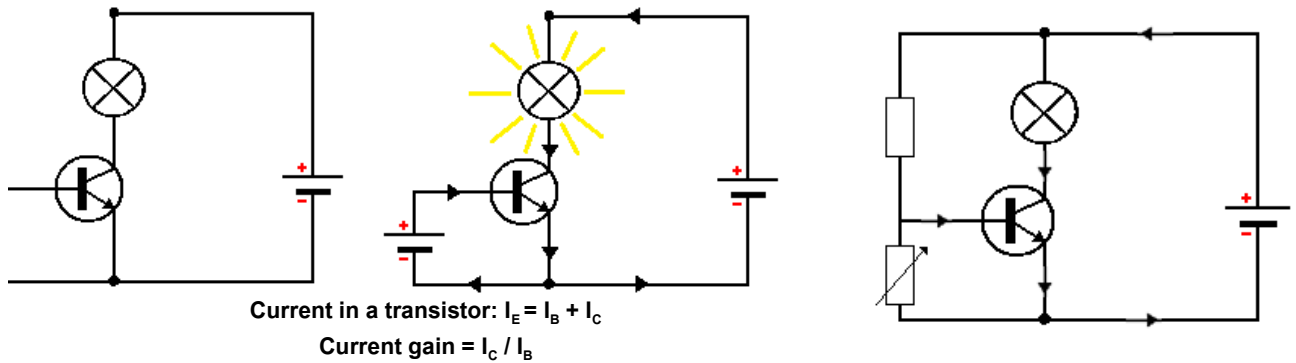

In the set up on the right, the transistor will switch on and the bulb will light when the resistance is high in the variable resistor. Using thermistors or a light-dependent resistor instead of the variable resistor, the circuit can act by itself for example a heater can switch on when it gets cold. The transistor will switch on when the voltage exceeds about 0.6V.

4.3 (d) Digital electronics

•**Analogue** uses a whole range of **continuous variations** to transmit a signal. **Digital** signals use only 2 states, on and off. With on and off signals logic gates can be used to manipulate these. **Logic gates** are processors (manipulate the signals) that are circuits containing transistors and other components. Here are the logic gates that we need to know:

| Gate | Symbol | Input A | Input B | Output |
|-----------|--------|------------------|------------------|------------------|
| NOT Gate | | 0 1 | None | 1 0 |
| AND Gate | | 0 0 1 1 | 0 1 0 1 | 0 0 0 1 |
| OR Gate | | 0 0 1 1 | 0 1 0 1 | 0 1 1 1 |
| NAND Gate | | 0 0 1 1 | 0 1 0 1 | 1 1 1 0 |
| NOR Gate | | 0 0 1 1 | 0 1 0 1 | 1 0 0 0 |

4.4 Dangers of electricity

- Damaged insulation: contact with the wire (live wire especially) due to gap in the insulation causes electric shock which can cause serious injury or shock.
- Overheating of cables: when long extension leads are coiled up, they may overheat. The current warms the wire, but the heat has less area to escape from a tight bundle. This might cause a fire.
- Damp conditions: water can conduct a current, so if electrical equipment is wet someone might get electrocuted YAY!
- Fuses**: a thin piece of wire which overheats and melts (the fuse 'blows') if the current is too high. It is placed on the live wire before the switch. This prevents overheating and catching fire. A fuse will have a specific current value (e.g. 13A) so when choosing a suitable fuse you must use the one which can have the lowest current value but over the current value of the appliance.

*The plug:

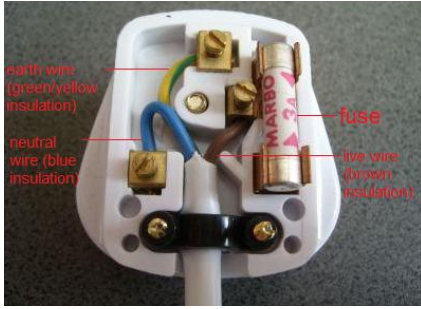

•**Circuit breakers:** an automatic switch which if the current rises over a specified value, the electromagnet pulls the contacts apart, breaking the circuit. The reset button is to reset everything. It works like a fuse but is better because it can be reset.

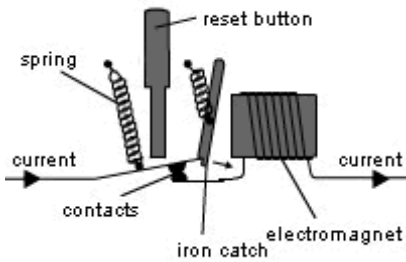

4.5 Electromagnetic effects

4.5 (a) Electromagnetic induction

•An induced EMF can be made in several ways:

1. If a wire is passed across a magnetic field, a small EMF is induced, this is **electromagnetic induction**. If the wire forms part of a complete circuit, the EMF makes a current flow. This can be detected using a galvanometer. The EMF induced in a conductor is proportional to the rate at which the magnetic field lines are cut by the conductor.

The induced EMF can be increased by:

- moving the wire faster
- using a stronger magnet
- increasing the length of wire in the magnetic field – for example, looping the wire through the field several times.

The current and EMF direction can be reversed by:

- moving the wire in the opposite direction
- turning the magnet round so that the field direction is reversed

The current direction is given by **Fleming's right-hand rule:**

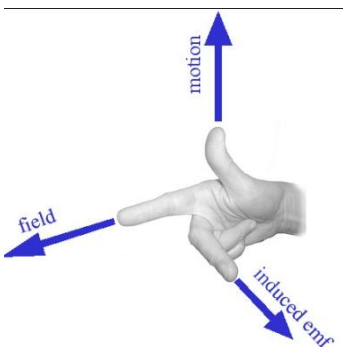
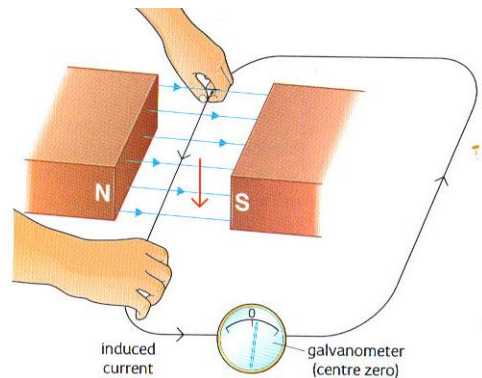

2. A bar magnet is pushed into a coil. If the coil is part of a circuit, a current will flow;

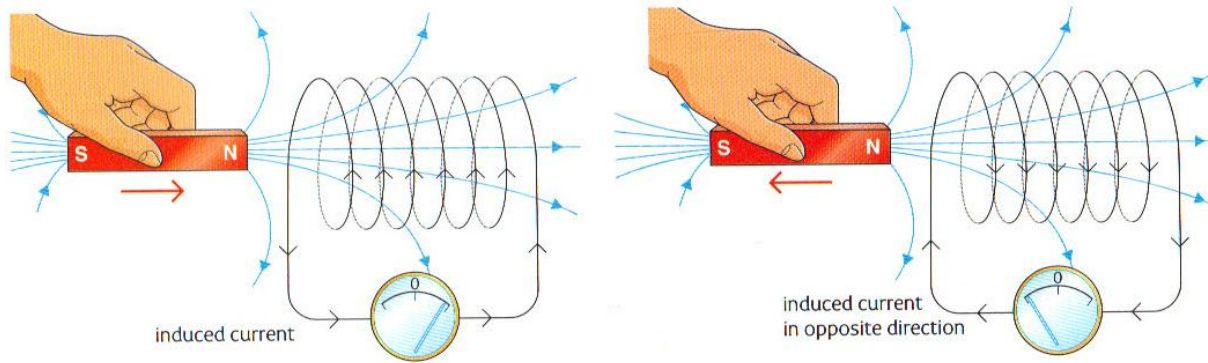

The induced EMF (and current) can be increased by:

- moving the magnet faster
- using a stronger magnet
- increasing the number of turns in the coil

-If the magnet is pulled away, the direction of the induced EMF (and current) is reversed

-using the S pole instead of the N pole reverses the direction of the induced EMF (and current)

-if the magnet is held still, there is no EMF

An induced current always flows in a direction such that it opposes the change which produced it. When a magnet is moved towards a coil the pole of the coil and magnet next to each other are the same. When the magnet is moved away the poles are opposite (opposite poles attract). The pole-type (north or south) is controlled by the direction in which the current is induced. The direction of the current is given by the **right-hand grip rule**:

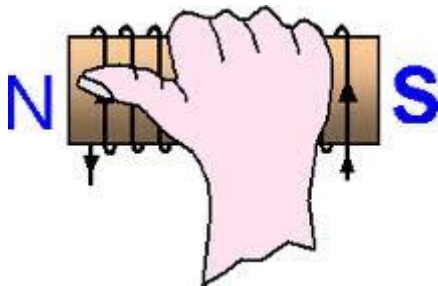

The fingers point in the conventional current direction and the thumb gives the North Pole.

4.5 (b) A.C. generator

- The coil is made of insulated copper wire and is rotated by turning the shaft. The **slip rings** are fixed to the coil and rotate with it. The **brushes** are 2 contacts which rub against the slip rings and keep the coil connected to the outside part of the circuit, usually made of carbon. When the coil is rotated, it cuts magnetic field lines, so an EMF is generated, which makes a current flow. Each side of the coil travels upwards then downwards then upwards etc. so the current flows backwards then forwards then backwards etc. so it is an alternating current. The current is maximum when the coil is horizontal since field lines are being cut at the fastest rate and 0 when the coil is vertical, since it is cutting NO field lines. The EMF can be increased by:
 - increasing the number of turns on the coil
 - increasing the area of the coil
 - using a stronger magnet
 - rotating the coil faster

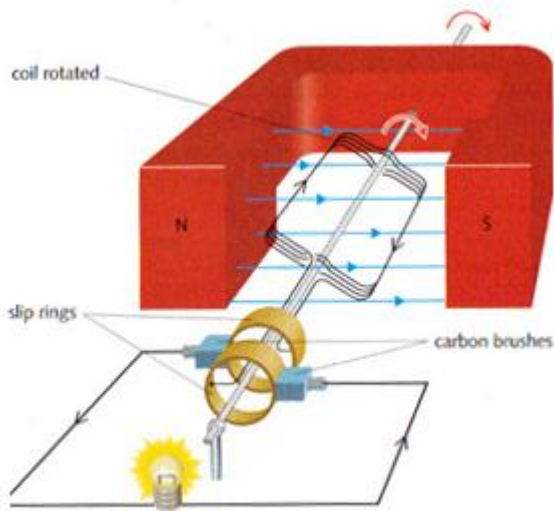

Simple AC generator, connected to a bulb

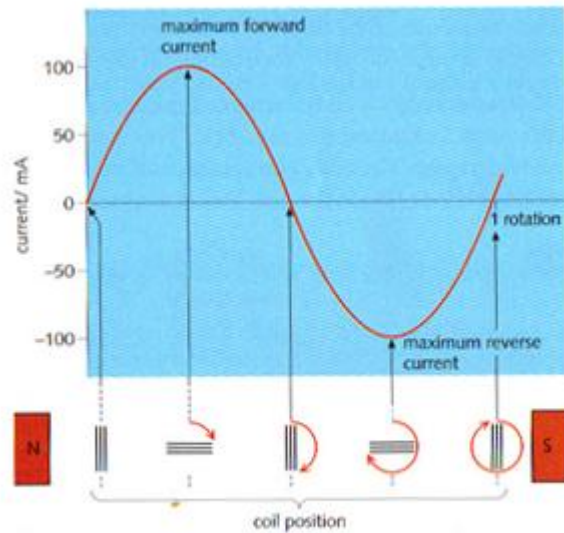

Graph showing the generator's AC output

4.5 (c) Transformer

•AC currents (only, not DC) can be increased or decreased by using a transformer. A transformer is made of a **primary/input coil**, a **secondary/output coil** and an **iron core**. The iron core gets magnetised by the incoming current. This magnetism then creates a current in the leaving wire. The power is the same on both sides (since we assume 100% efficiency and that all the field lines pass through both coils). You can figure out the number of coils and the voltage with:

Output voltage / Input voltage = Turns on output coil / Turns on input coil

$$V_2 / V_1 = n_2 / n_1$$

Input voltage × input current = output voltage × output current

$$V_1 \times I_1 = V_2 \times I_2$$

$$\text{Power}_1 = \text{Power}_2$$

A transformer works by **mutual induction**. As you saw before, an EMF (and current) can be induced by *moving* a magnetic field. A *changing* magnetic field can have the same effect. Turning an electromagnet next to a coil on or off will induce a very short-lasting EMF in the coil, but leaving the electromagnet on will not, since the magnetic field is not changing. Switching the electromagnet off will induce an EMF in the opposite direction of switching it on. The EMF can be increased if the core of the electromagnet goes right through the second coil or increasing the number of coils in the second coil. An alternating current in a transformer's primary coil creates an alternating magnetic field in the core and therefore in the second coil. The alternating magnetic field creates an alternating voltage in the second coil.

- A step-up transformer increases the voltage and a step-down transformer decreases it.
- Transformers are used to make high voltage AC currents. Since power lost in a resistor = $R \times I^2$, having a lower current will decrease the power loss. Since transmission cables are many kilometres long they have a lot of resistance, so a transformer is used to increase the voltage and decrease the current to decrease power lost.
- The advantages of high-voltage transmission:
 - less power lost
 - thinner, light, and cheaper cables can be used since current is reduced

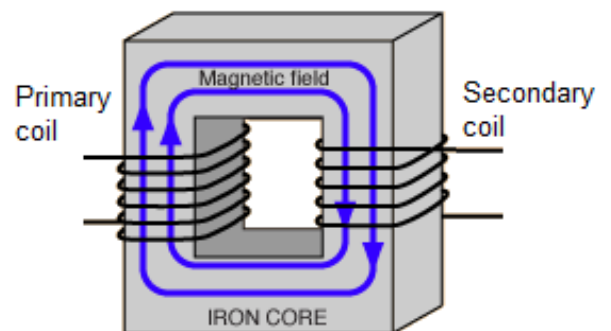

4.5 (d) The magnetic effect of a current

- Magnetic field around a current carrying wire and a solenoid:

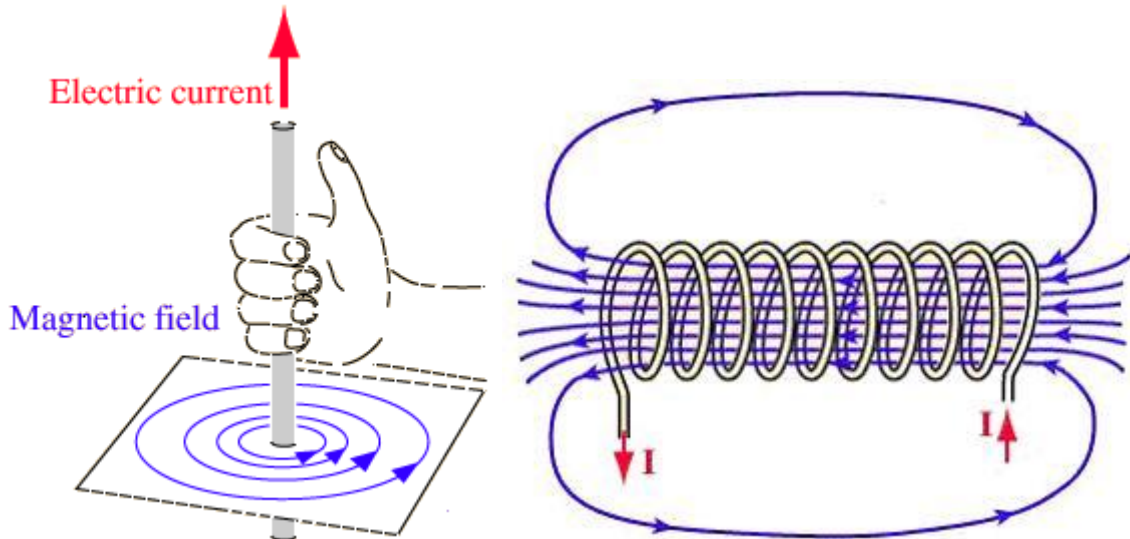

1. Increasing the current increases the strength of the field
 2. Increasing the number of turns of a coil increases the strength.
 3. Reversing the current direction reverses the magnetic field direction (right-hand rule).
- The magnetic effect of current is used in a relay and a circuit breaker.

4.5 (e) Force on a current-carrying conductor

•If a current carrying conductor is in a magnetic field, it warps the field lines. The field lines from the magnet want to straighten out naturally. This causes a catapult like action on the wire creating a force. The direction of the force, current or magnetic field is given by **Fleming's left-hand rule**:

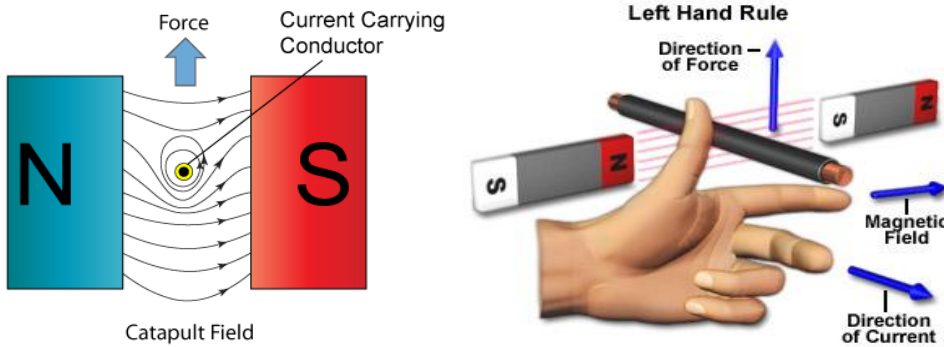

- if you reverse the current, you will reverse the direction of the force
- if you reverse the direction of the field, you will reverse the direction of the force.

• “Describe an experiment to show the corresponding force on beams of charged particles”

An electron gun creates a beam of electrons. The screen is coated with a fluorescent material which glows when electrons strike it. Current is passed through a pair of coils, to create a magnetic field. **NOTE:** the direction of the electron beam is the opposite to the conventional current direction so when using the left-hand rule you have to point in the opposite direction of the electron beam.

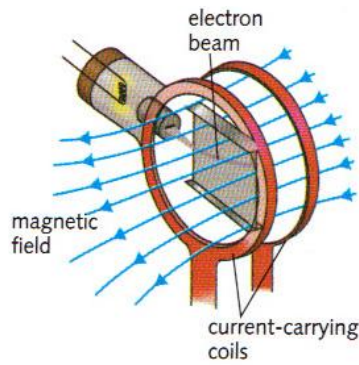

Magnetic deflection

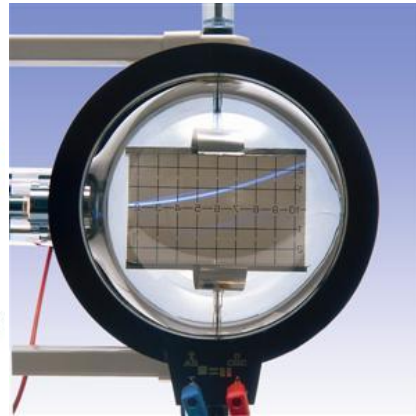

4.5 (f) d.c. motor

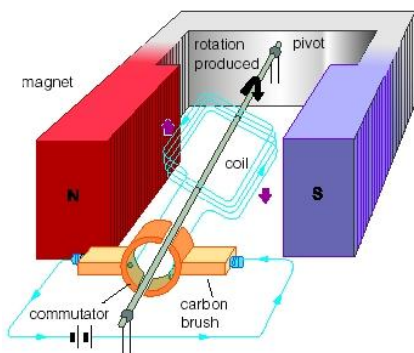

•When a current-carrying coil is in a magnetic field, it experiences a turning effect. A DC motor runs on a direct current. The coil is made of insulated copper wire. It is free to rotate between the poles of the magnet. The **commutator**, or split-ring, is fixed to the coil and rotates with it. When the coil overshoots the vertical, the commutator changes the direction of the current through it, so the forces change direction and keep the coil turning. The **brushes** are two contacts which rub against the commutator and keep the coil connected to the battery. They are usually made of carbon. The maximum turning effect is when the coil is horizontal. There is no force when the coil is vertical (but luckily it always overshoots this position).

- The turning effect can be increased by:
 - increasing the current
 - using a stronger magnet
 - increasing the number of coils (increases the length of coil)
 - increasing the area of the coil (increases the length of coil)
- Reversing the rotation can be done by:
 - reversing the battery
 - reversing the poles

This equation isn't needed but is useful for remembering the ways to increase the turning effect:

Force exerted on wire = magnetic field strength × current × length of wire

4.6 Cathode-ray oscilloscopes

4.6 (a) Cathode rays

Cathode rays are **thermionic emissions** – if a metal or metal oxide filament is heated (to about 2000°C for tungsten), **electrons** can escape it. So a thermionic emission is made of electrons. The hot conductor is the **cathode** (-). The other electrode is the **anode** (+). When the filament (cathode) is heated, a current flows to the anode. This happens in a **vacuum tube** (in air the electrons would collide with air particles and the filament would burn). A vacuum tube is also called a **thermionic diode**, as the electrons can only pass one way. The current can be detected with a milliammeter.

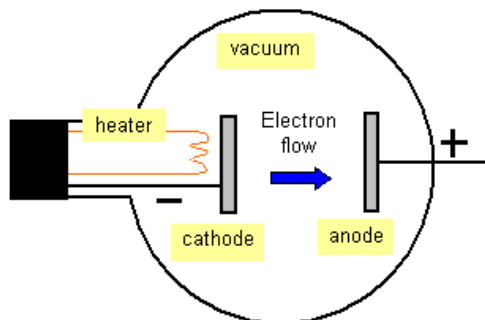

4.6 (b) Simple treatment of cathode-ray oscilloscope

A cathode-ray oscilloscope is structured like this

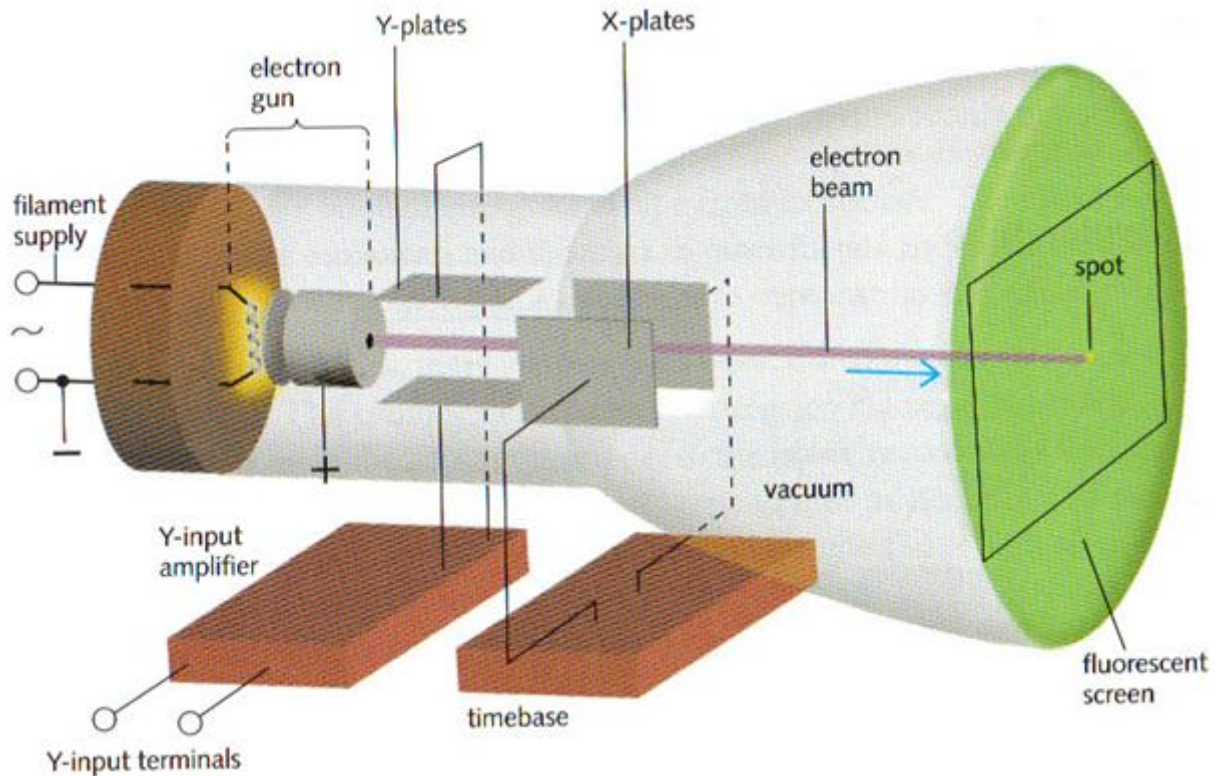

- There is a bright spot on the fluorescent screen where the beam of electrons hits it. If you deflect the beam, the spot can be moved. If the spot moves fast enough, it appears to be a line. The beam is deflected using 2 sets of deflection plates:

- Y-plates move the beam vertically. The amount of vertical movement can be increased by turning up the gain control. (A gain control of 5V/cm means the spot is deflected 1cm vertically for every 5 volts across the Y-input terminals).

- direct current moves the position of the spot
- alternating current makes the spot oscillate vertically

- X-plates move the beam horizontally, controlled by a circuit called a timebase.

- if the timebase is on, the spot moves horizontally with a steady speed
- if the timebase is on and there is AC voltage across the Y-plates, then the spot oscillates vertically and moves horizontally at steady speed. If the timebase is set at 10ms/cm that means it takes 10 milliseconds to move a cm horizontally.

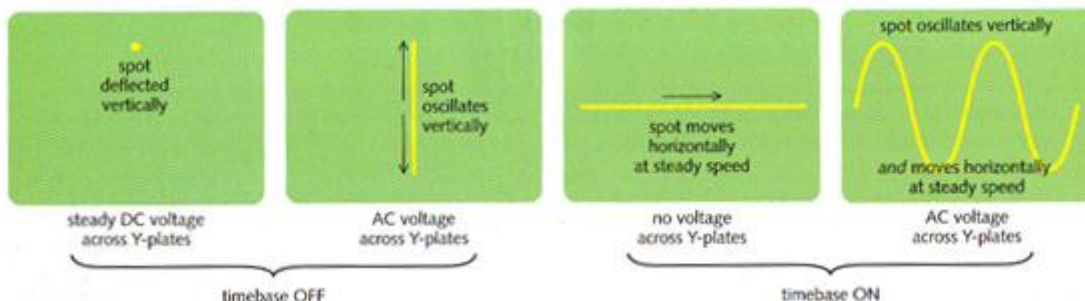

- The period is given by:

Period = peak-to-peak distance × timebase control (basically time = distance × speed)

Frequency = 1 / period

- The beam can also be deflected using a magnetic field (see the end of 4.5 (d) the magnetic affect of a current)

This was not in the syllabus but just in case:

The charge of an electron is 1.6×10^{-19} **Coulombs**. This is called the electronic charge.

5. Atomic physics

5.1 Radioactivity

5.1 (a) Detection of radioactivity

•**Background radiation:** the small amount of radiation around us all the time because of radioactive materials in the environment. It mainly comes from natural sources such as soil, rocks, air, building materials, food and drink – and even space.

•**Detection:**

Alpha particles – **the cloud chamber:**

A chamber has cold alcohol vapour inside it. The alpha particles make the vapour condense, so you see a trail of tiny droplets. It is useful because it makes the tracks visible.

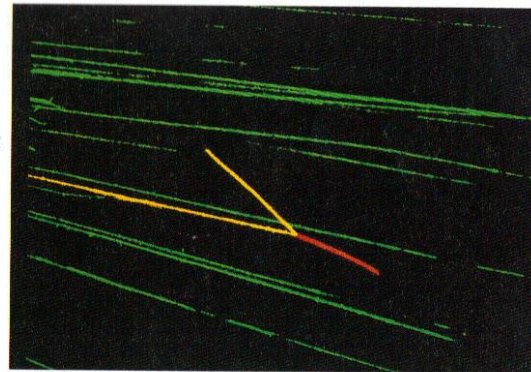
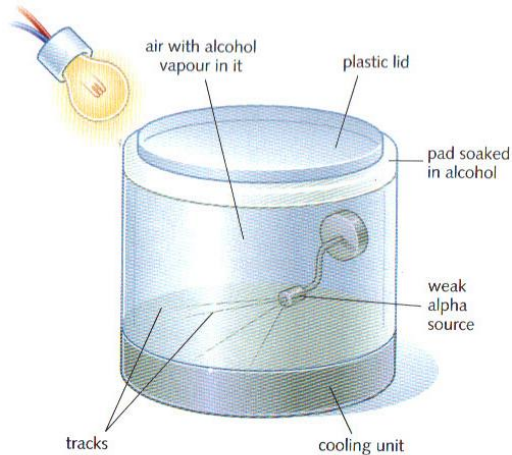

Tracks of alpha particles in a cloud chamber. The colours are false and have been added to the picture. The green and yellow lines are the alpha tracks. The red line is the track of a nitrogen nucleus that has been hit by an alpha particle.

Cloud chamber

Alpha, Beta and Gamma – the **Geiger-Müller (GM) tube**

The “window” end is thin enough for alpha particles to pass through. If an alpha particle enters the tube, it ionizes the gas inside. This sets off a high-voltage spark across the gas and a pulse of current in the circuit. A beta particle or gamma radiation has the same effect. It can be connected to a ratemeter (tells the counts per seconds), a scaler (tells the total number of particles or bursts of gamma radiation) or an amplifier or loudspeaker (makes a click for every particles/burst of radiation).

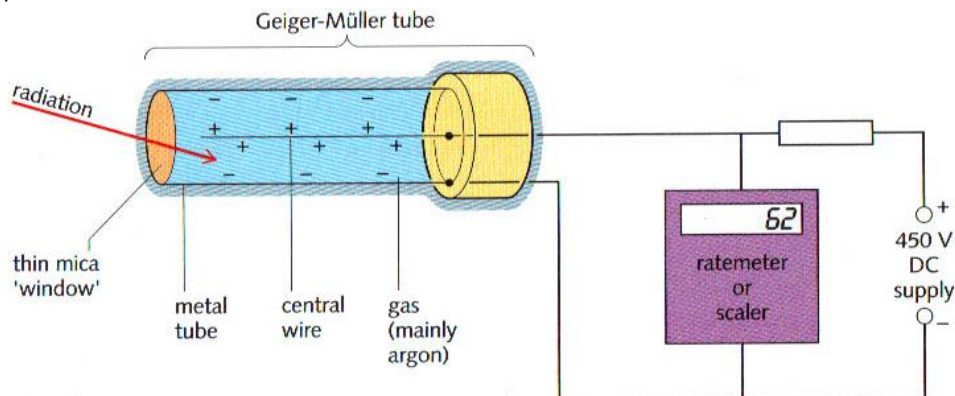

5.1 (b) Characteristics of the three kinds of emission

| | Alpha particles (α) | Beta particles (β) | Gamma rays (γ) |
|--------------------|------------------------------------|------------------------------------|---|
| Made of... | 2 protons and 2 neutrons | 1 high energy electron | Electromagnetic radiation |
| Charge | +2 | -1 | 0 |
| Mass | 4 | 1/1840 | 0 |
| Speed | 0.1 x speed of light | 0.9 x speed of light | speed of light |
| Ionizing effect | Strong | Weak | Very weak |
| Penetration | Not penetrating; stopped by paper. | Penetrating; stopped by aluminium. | Very penetrating; only reduced by thick lead. |
| Effect from fields | Deflected | Very deflected | Not deflected |

5.1 (c) Radioactive decay

Radioactive decay: A **radioisotope** (an unstable arrangement of neutrons and protons in a nucleus) is altered to make a more stable arrangement. The **parent** nucleus becomes a **daughter** nucleus and a particle (**decay products**).

Words and symbol equations using examples:

•Alpha decay:

An element with a proton number 2 lower and nucleon number 4 lower, and an alpha particle is made ($2p + 2n$) e.g.

Words: Radium-226 nucleus (parent nucleus) \rightarrow Radon-222 (daughter nucleus) + helium-4 nucleus (alpha particle)

Symbols: ${}_{88}^{226}\text{Ra} \rightarrow {}_{86}^{222}\text{Rn} + {}_2^4\text{He}$

•Beta decay:

A neutron changes into a proton, an electron and an antineutrino so an element with the same nucleon number (just 1 neutron is now a proton but the mass is the same) but with a proton number 1 higher e.g.

Words: iodine-131 nucleus \rightarrow xenon-131 nucleus + antineutrino + beta particles (electron)

Symbols: ${}_{53}^{131}\text{I} \rightarrow {}_{54}^{131}\text{Xe} + {}_{-1}^0\beta + {}_0^0\bar{\nu}$ (antineutrino symbol = $\bar{\nu}$ with a horizontal line on top of it)

•Gamma emission:

With some isotopes, the emission of an alpha or beta particle from a nucleus leaves the protons and neutrons in an "excited" arrangement. As the protons and neutrons rearrange to become more stable, they lose energy. This is emitted and the mass and atomic number are unchanged.

Gamma emission by itself causes no change in mass number or atomic number.

5.1 (d) Half-life

•Half-life of a radioisotope: is the time taken for half the nuclei present in any given sample to decay.

Some nuclei are more stable than others.

5.1 (e) Safety precautions

•radioactive stuff is stored in a lead container, in a locked cabinet

•picked up with tongs, not your feet

•kept away from the body, not pointed at people

•left out of its container for as short a time as possible

5.2 The nuclear atom

5.2 (a) Atomic model

•Atoms consist of:

A nucleus – the central part of the atom made of **protons** (positively charged) and **neutrons**. These two types of particles are called **nucleons**. They are bound together by the **strong nuclear force**.

Electrons – almost mass-less particles which orbit the nucleus in shells.

Rutherford's experiment:

Thin gold foil is bombarded with alpha particles, which are positively charged. Most passed straight through, but few were repelled so strongly that they were bounced back or deflected at large angles. Rutherford concluded that the atom must be largely empty space, with its positive charge and most of its mass concentrated in a tiny nucleus.

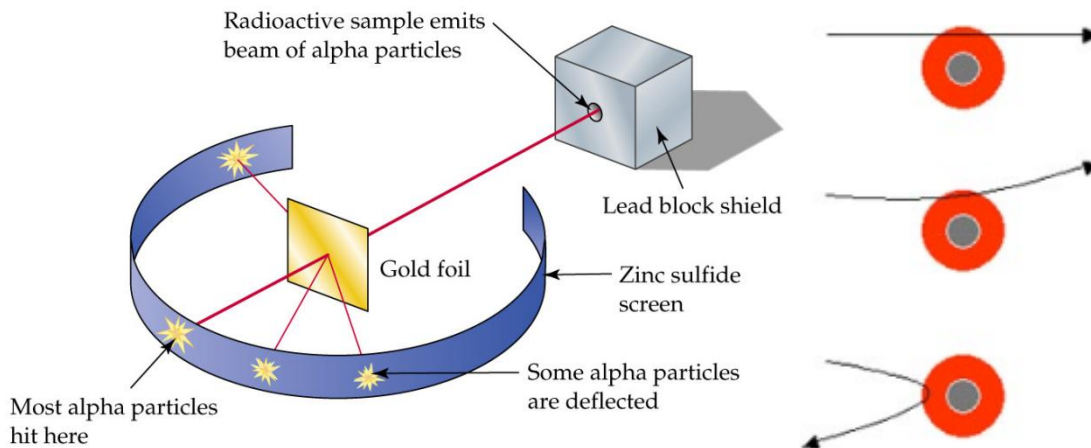

5.2 (b) Nucleus

- The nucleus is composed of protons and neutrons.
- Proton number:** is the number of protons in an atom (you don't say)
- Nucleon number:** the number of nucleons (protons and neutrons) in an atom

5.2 (c) Isotopes

Isotope: atoms of the same element that have different numbers of neutrons
e.g. Carbon 12 and Carbon 14.

-There are **non-radioactive isotopes** and **radio-isotopes**. Radio isotopes are unstable atoms, which break down giving radiation.

-**Medical use:** cancer treatment (radiotherapy) – rays kill cancer cells using cobalt-60.

Industrial use: to check for leaks – radioisotopes called tracers are added to oil or gas. At the leaks radiation is detected using a Geiger counter, (if you need to name an element then say carbon 14 – used for carbon dating).

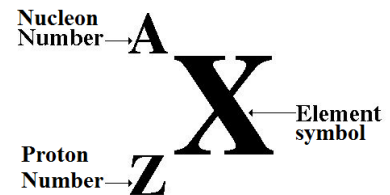

This might be useful:

| prefix | meaning | power | example |
|-----------|-----------------|---------------------|-----------------|
| G (giga) | 1 000 000 000 | (10 ⁹) | GHz (GigaHertz) |
| M (mega) | 1 000 000 | (10 ⁶) | MW (megawatt) |
| k (kilo) | 1000 | (10 ³) | km (kilometre) |
| d (deci) | 1/10 | (10 ⁻¹) | dm (decimetre) |
| c (centi) | 1/100 | (10 ⁻²) | cm (centimetre) |
| m (milli) | 1/1 000 | (10 ⁻³) | mm (millimetre) |
| μ (micro) | 1/1 000 000 | (10 ⁻⁶) | μW (microwatt) |
| n (nano) | 1/1 000 000 000 | (10 ⁻⁹) | nm (nanometre) |

[Return to the top of the document](#)